



Installer and user reference guide
Split system air conditioners

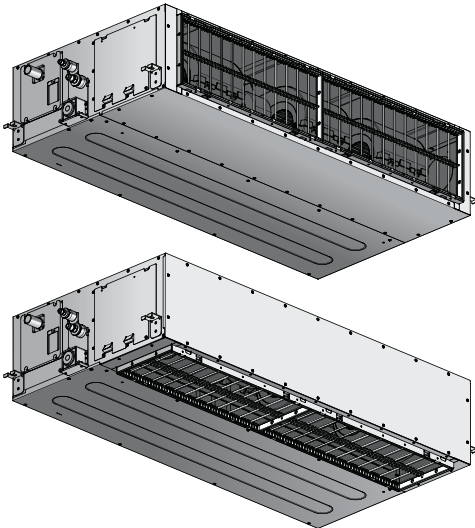

Table of Contents

1	About the documentation	4
1.1	About this document	4
1.2	Meaning of warnings and symbols	5
2	General safety precautions	7
2.1	For the installer	7
2.1.1	General	7
2.1.2	Installation site	8
2.1.3	Refrigerant — in case of R410A or R32	11
2.1.4	Electrical	13
3	Specific installer safety instructions	16
For the user		19
4	User safety instructions	20
4.1	General	20
4.2	Instructions for safe operation	21
5	About the system	26
5.1	System layout	26
5.2	Information requirements for fan coil units	27
6	User interface	28
7	Before operation	29
8	Operation	30
8.1	Operation range	30
8.2	About operation modes	30
8.2.1	Basic operation modes	31
8.2.2	Special heating operation modes	31
8.3	To operate the system	31
9	Energy saving and optimum operation	32
10	Maintenance and service	33
10.1	Precautions for maintenance and service	33
10.2	Cleaning the air filter and air outlet	33
10.2.1	To clean the air filter	33
10.2.2	To clean the air outlet	34
10.3	Maintenance before a long stop period	34
10.4	Maintenance after a long stop period	35
10.5	About the refrigerant	35
11	Troubleshooting	37
11.1	Symptoms that are NOT system malfunctions	38
11.1.1	Symptom: The system does not operate	38
11.1.2	Symptom: White mist comes out of a unit (Indoor unit)	39
11.1.3	Symptom: White mist comes out of a unit (Indoor unit, outdoor unit)	39
11.1.4	Symptom: The user interface reads "U4" or "U5" and stops, but then restarts after a few minutes	39
11.1.5	Symptom: Noise of air conditioners (Indoor unit)	39
11.1.6	Symptom: Noise of air conditioners (Indoor unit, outdoor unit)	40
11.1.7	Symptom: Dust comes out of the unit	40
11.1.8	Symptom: The units can give off odours	40
12	Relocation	41
13	Disposal	42
For the installer		43
14	About the box	44
14.1	Indoor unit	44
14.1.1	To unpack and handle the unit	44
14.1.2	To remove the accessories from the indoor unit	45

15 About the units and options	46
15.1 Identification	46
15.1.1 Identification label: Indoor unit	46
15.2 About the indoor unit	46
15.3 System layout	47
15.4 Combining units and options	47
15.4.1 Possible options for the indoor unit	48
16 Unit installation	49
16.1 Preparing the installation site	49
16.1.1 Installation site requirements of the indoor unit	49
16.2 Mounting the indoor unit	51
16.2.1 Guidelines when installing the indoor unit	51
16.2.2 Guidelines when installing the ducting	54
16.2.3 Guidelines when installing the drain piping	55
17 Piping installation	59
17.1 Preparing refrigerant piping	59
17.1.1 Refrigerant piping requirements	59
17.1.2 Refrigerant piping insulation	60
17.2 Connecting the refrigerant piping	60
17.2.1 About connecting the refrigerant piping	60
17.2.2 Precautions when connecting the refrigerant piping	60
17.2.3 Guidelines when connecting the refrigerant piping	61
17.2.4 Pipe bending guidelines	62
17.2.5 To flare the pipe end	62
17.2.6 To connect the refrigerant piping to the indoor unit	63
18 Electrical installation	64
18.1 About connecting the electrical wiring	64
18.1.1 Precautions when connecting the electrical wiring	64
18.1.2 Guidelines when connecting the electrical wiring	65
18.1.3 Specifications of standard wiring components	67
18.2 To connect the electrical wiring to the indoor unit	67
19 Commissioning	71
19.1 Overview: Commissioning	71
19.2 Precautions when commissioning	71
19.3 Checklist before commissioning	71
19.4 To perform a test run	72
20 Configuration	73
20.1 Field setting	73
21 Hand-over to the user	75
22 Troubleshooting	76
22.1 Solving problems based on error codes	76
22.1.1 Error codes: Overview	76
23 Disposal	77
24 Technical data	78
24.1 Wiring diagram	78
24.1.1 Unified wiring diagram legend	78
25 Glossary	81

1 About the documentation

1.1 About this document



WARNING

Make sure installation, servicing, maintenance, repair and applied materials follow the instructions from Daikin (including all documents listed in “Documentation set”) and, in addition, comply with applicable legislation and are performed by qualified persons only. In Europe and areas where IEC standards apply, EN/IEC 60335-2-40 is the applicable standard.



INFORMATION

Make sure that the user has the printed documentation and ask him/her to keep it for future reference.

Target audience

Authorised installers + end users



INFORMATION

This appliance is intended to be used by expert or trained users in shops, in light industry, and on farms, or for commercial and household use by lay persons.

Documentation set

This document is part of a documentation set. The complete set consists of:

- **General safety precautions:**
 - Safety instructions that you must read before installing
 - Format: Paper (in the box of the indoor unit)
- **Indoor unit installation and operation manual:**
 - Installation and operation instructions
 - Format: Paper (in the box of the indoor unit)
- **Installer and user reference guide:**
 - Preparation of the installation, good practices, reference data,...
 - Detailed step-by-step instructions and background information for basic and advanced usage
 - Format: Digital files on <https://www.daikin.eu>. Use the search function 🔍 to find your model.

Latest revisions of the supplied documentation may be available on the regional Daikin website or via your dealer.

Scan the QR code below to find the full documentation set and more information about your product on Daikin website.











The original documentation is written in English. All other languages are translations.



Technical engineering data

- A **subset** of the latest technical data is available on the regional Daikin website (publicly accessible).
- The **full set** of latest technical data is available on the Daikin Business Portal (authentication required).

1.2 Meaning of warnings and symbols



	DANGER Indicates a situation that results in death or serious injury.
	DANGER: RISK OF ELECTROCUTION Indicates a situation that could result in electrocution.
	DANGER: RISK OF BURNING/SCALDING Indicates a situation that could result in burning/scalding because of extreme hot or cold temperatures.
	DANGER: RISK OF EXPLOSION Indicates a situation that could result in explosion.
	WARNING Indicates a situation that could result in death or serious injury.
	WARNING: FLAMMABLE MATERIAL
	CAUTION Indicates a situation that could result in minor or moderate injury.
	NOTICE Indicates a situation that could result in equipment or property damage.
	INFORMATION Indicates useful tips or additional information.

Symbols used on the unit:

Symbol	Explanation
	Before installation, read the installation and operation manual, and the wiring instruction sheet.
	Before performing maintenance and service tasks, read the service manual.
	For more information, see the installer and user reference guide.

Symbol	Explanation
	The unit contains rotating parts. Be careful when servicing or inspecting the unit.

Symbols used in the documentation:

Symbol	Explanation
	Indicates a figure title or a reference to it. Example: "▲ 1-3 Figure title" means "Figure 3 in chapter 1".
	Indicates a table title or a reference to it. Example: "■ 1-3 Table title" means "Table 3 in chapter 1".

2 General safety precautions

2.1 For the installer

2.1.1 General

If you are NOT sure how to install or operate the unit, contact your dealer.



DANGER: RISK OF BURNING/SCALDING

- Do NOT touch the refrigerant piping, water piping or internal parts during and immediately after operation. It could be too hot or too cold. Give it time to return to normal temperature. If you MUST touch it, wear protective gloves.
- Do NOT touch any accidental leaking refrigerant.



WARNING

Improper installation or attachment of equipment or accessories could result in electrical shock, short-circuit, leaks, fire or other damage to the equipment. ONLY use accessories, optional equipment and spare parts made or approved by Daikin.



WARNING

Make sure installation, testing and applied materials comply with applicable legislation (on top of the instructions described in the Daikin documentation).



WARNING

Tear apart and throw away plastic packaging bags so that nobody, especially NOT children, can play with them. **Possible consequence:** suffocation.



WARNING

Provide adequate measures to prevent that the unit can be used as a shelter by small animals. Small animals that make contact with electrical parts can cause malfunctions, smoke or fire.



CAUTION

Wear adequate personal protective equipment (protective gloves, safety glasses,...) when installing, maintaining or servicing the system.



CAUTION

Do NOT touch the air inlet or aluminium fins of the unit.



CAUTION

- Do NOT place any objects or equipment on top of the unit.
- Do NOT sit, climb or stand on the unit.

In accordance with the applicable legislation, it might be necessary to provide a logbook with the product containing at least: information on maintenance, repair work, results of tests, stand-by periods,...

Also, at least, following information MUST be provided at an accessible place at the product:

- Instructions for shutting down the system in case of an emergency
 - Name and address of fire department, police and hospital
 - Name, address and day and night telephone numbers for obtaining service
- In Europe, EN378 provides the necessary guidance for this logbook.

2.1.2 Installation site

- Provide sufficient space around the unit for servicing and air circulation.
- Make sure the installation site withstands the weight and vibration of the unit.
- Make sure the area is well ventilated. Do NOT block any ventilation openings.
- Make sure the unit is level.

Do NOT install the unit in the following places:

- In potentially explosive atmospheres.
- In places where there is machinery that emits electromagnetic waves. Electromagnetic waves may disturb the control system, and cause malfunction of the equipment.
- In places where there is a risk of fire due to the leakage of flammable gases (example: thinner or gasoline), carbon fibre, ignitable dust.
- In places where corrosive gas (example: sulphurous acid gas) is produced. Corrosion of copper pipes or soldered parts may cause the refrigerant to leak.

Instructions for equipment using R32 refrigerant



WARNING

- Do NOT pierce or burn refrigerant cycle parts.
- Do NOT use cleaning materials or means to accelerate the defrosting process other than those recommended by the manufacturer.
- Be aware that the refrigerant inside the system is odourless.



WARNING

The appliance shall be stored so as to prevent mechanical damage and in a well-ventilated room without continuously operating ignition sources (example: open flames, an operating gas appliance or an operating electric heater) and have a room size as specified below.



WARNING

Make sure installation, servicing, maintenance and repair comply with instructions from Daikin and with applicable legislation and are executed ONLY by authorised persons.

**WARNING**

If one or more rooms are connected to the unit using a duct system, make sure:

- there are no operating ignition sources (example: open flames, an operating gas appliance or an operating electric heater) in case the floor area is less than the minimum floor area A (m²).
- no auxiliary devices, which may be a potential ignition source, are installed in the duct work (example: hot surfaces with a temperature exceeding 700°C and electric switching device);
- only auxiliary devices approved by the manufacturer are used in the duct work;
- air inlet AND outlet are connected directly to the same room by ducting. Do NOT use spaces such as a false ceiling as a duct for the air inlet or outlet.

**WARNING**

- Take precautions to avoid excessive vibration or pulsation to refrigeration piping.
- Protect the protection devices, piping and fittings as much as possible against adverse environmental effects.
- Provide space for expansion and contraction of long runs of piping.
- Design and install piping in refrigerating systems such as to minimise the likelihood of hydraulic shock damaging the system.
- Mount the indoor equipment and pipes securely and protect them to avoid accidental rupture of equipment or pipes in case of events such as moving furniture or reconstruction activities.

**CAUTION**

- Incomplete flaring may cause refrigerant gas leakage.
- Do NOT re-use flares. Use new flares to prevent refrigerant gas leakage.
- Use flare nuts that are included with the unit. Using different flare nuts may cause refrigerant gas leakage.

**CAUTION**

Do NOT use potential sources of ignition in searching for or detection of refrigerant leaks.

**NOTICE**

- Do NOT re-use joints and copper gaskets which have been used already.
- Joints made in installation between parts of refrigerant system shall be accessible for maintenance purposes.

Installation space requirements**WARNING**

If appliances contain R32 refrigerant, the floor area of the room in which the appliances are installed, operated and stored **MUST** be larger than the minimum floor area defined in table below A (m²). This applies to:

- Indoor units **without** a refrigerant leakage sensor; in case of indoor units **with** refrigerant leakage sensor, consult the installation manual
- Outdoor units installed or stored indoors (e.g. winter garden, garage, machinery room)



NOTICE

- Protect pipework from physical damage.
- Keep the pipework installation to a minimum.

To determine the minimum floor area

- 1 Determine the total refrigerant charge in the system (= factory refrigerant charge ① + ② additional refrigerant amount charged).

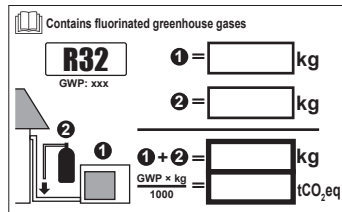

- 2 Determine which graph or table to use.
 - For indoor units: Is the unit ceiling-mounted, wall-mounted or floor-standing?
 - For outdoor units installed or stored indoors, this depends on the installation height:

If the installation height is...	Then use the graph or table for...
<1.8 m	Floor-standing units
1.8 ≤ x < 2.2 m	Wall-mounted units
≥ 2.2 m	Ceiling-mounted units

- 3 Use the graph or table to determine the minimum floor area.

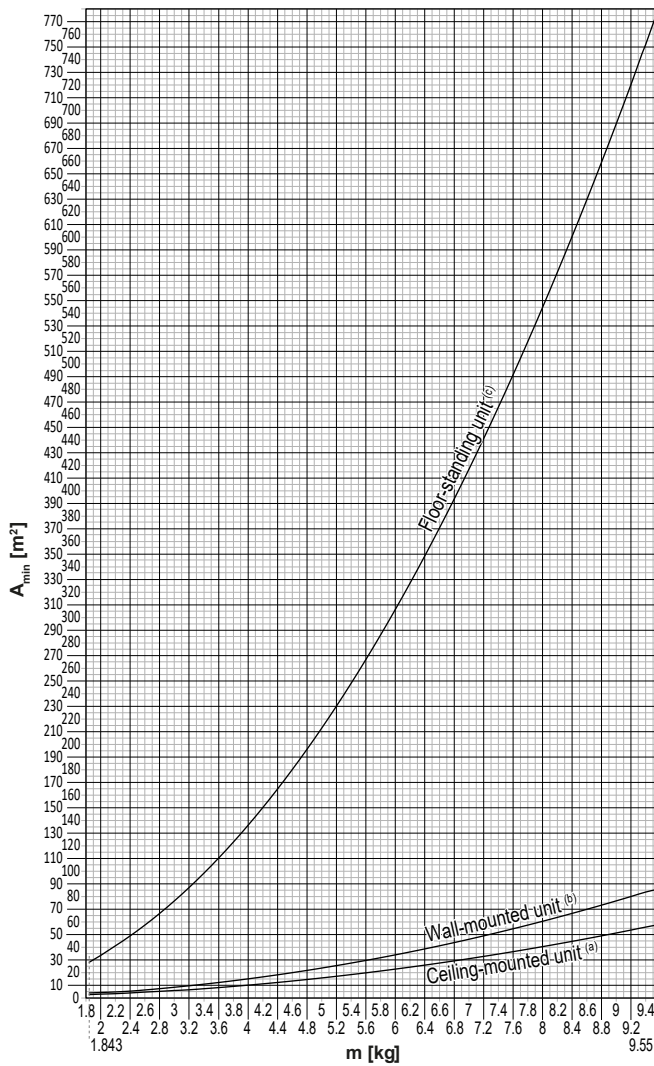

Ceiling-mounted unit ^(a)		Wall-mounted unit ^(b)		Floor-standing unit ^(c)	
m (kg)	A _{min} (m ²)	m (kg)	A _{min} (m ²)	m (kg)	A _{min} (m ²)
≤1.842	—	≤1.842	—	≤1.842	—
1.843	3.64	1.843	4.45	1.843	28.9
2.0	3.95	2.0	4.83	2.0	34.0
2.2	4.34	2.2	5.31	2.2	41.2
2.4	4.74	2.4	5.79	2.4	49.0
2.6	5.13	2.6	6.39	2.6	57.5
2.8	5.53	2.8	7.41	2.8	66.7
3.0	5.92	3.0	8.51	3.0	76.6
3.2	6.48	3.2	9.68	3.2	87.2
3.4	7.32	3.4	10.9	3.4	98.4
3.6	8.20	3.6	12.3	3.6	110
3.8	9.14	3.8	13.7	3.8	123
4.0	10.1	4.0	15.1	4.0	136
4.2	11.2	4.2	16.7	4.2	150
4.4	12.3	4.4	18.3	4.4	165
4.6	13.4	4.6	20.0	4.6	180
4.8	14.6	4.8	21.8	4.8	196
5.0	15.8	5.0	23.6	5.0	213
5.2	17.1	5.2	25.6	5.2	230
5.4	18.5	5.4	27.6	5.4	248
5.6	19.9	5.6	29.7	5.6	267
5.8	21.3	5.8	31.8	5.8	286
6.0	22.8	6.0	34.0	6.0	306
6.2	24.3	6.2	36.4	6.2	327
6.4	25.9	6.4	38.7	6.4	349
6.6	27.6	6.6	41.2	6.6	371
6.8	29.3	6.8	43.7	6.8	394
7.0	31.0	7.0	46.3	7.0	417
7.2	32.8	7.2	49.0	7.2	441
7.4	34.7	7.4	51.8	7.4	466
7.6	36.6	7.6	54.6	7.6	492
7.8	38.5	7.8	57.5	7.8	518
8	40.5	8	60.5	8	545
8.2	42.6	8.2	63.6	8.2	572
8.4	44.7	8.4	66.7	8.4	601
8.6	46.8	8.6	69.9	8.6	629
8.8	49.0	8.8	73.2	8.8	659
9	51.3	9	76.6	9	689
9.2	53.6	9.2	80.0	9.2	720
9.4	55.9	9.4	83.6	9.4	752
9.55	57.7	9.55	86.2	9.55	776

- m** Total refrigerant charge in the system
- A_{min}** Minimum floor area
- (a)** Ceiling-mounted unit (= Ceiling-mounted unit)
- (b)** Wall-mounted unit (= Wall-mounted unit)
- (c)** Floor-standing unit (= Floor-standing unit)

2.1.3 Refrigerant — in case of R410A or R32

If applicable. See the installation manual or installer reference guide of your application for more information.



DANGER: RISK OF EXPLOSION

Pump down – Refrigerant leakage. If you want to pump down the system, and there is a leak in the refrigerant circuit:

- Do NOT use the unit's automatic pump down function, with which you can collect all refrigerant from the system into the outdoor unit. **Possible consequence:** Self-combustion and explosion of the compressor because of air going into the operating compressor.
- Use a separate recovery system so that the unit's compressor does NOT have to operate.



WARNING

During tests, NEVER pressurise the product with a pressure higher than the maximum allowable pressure (as indicated on the nameplate of the unit).



WARNING

Take sufficient precautions in case of refrigerant leakage. If refrigerant gas leaks, ventilate the area immediately. Possible risks:

- Excessive refrigerant concentrations in a closed room can lead to oxygen deficiency.
- Toxic gas might be produced if refrigerant gas comes into contact with fire.



WARNING

ALWAYS recover the refrigerant. Do NOT release them directly into the environment. Use a vacuum pump to evacuate the installation.



WARNING

Make sure there is no oxygen in the system. Refrigerant may ONLY be charged after performing the leak test and the vacuum drying.

Possible consequence: Self-combustion and explosion of the compressor because of oxygen going into the operating compressor.



NOTICE

- To avoid compressor breakdown, do NOT charge more than the specified amount of refrigerant.
- When the refrigerant system is to be opened, refrigerant MUST be treated according to the applicable legislation.



NOTICE

Make sure refrigerant piping installation complies with applicable legislation. In Europe, EN378 is the applicable standard.



NOTICE

Make sure the field piping and connections are NOT subjected to stress.



NOTICE

After all the piping has been connected, make sure there is no gas leak. Use nitrogen to perform a gas leak detection.

- In case recharge is required, see the nameplate of the unit. It states the type of refrigerant and necessary amount.
- The unit is factory charged with refrigerant and depending on pipe sizes and pipe lengths some systems require additional charging of refrigerant.
- ONLY use tools exclusively for the refrigerant type used in the system, this to ensure pressure resistance and prevent foreign materials from entering into the system.
- Charge the liquid refrigerant as follows:

If	Then
A siphon tube is present (i.e., the cylinder is marked with "Liquid filling siphon attached")	Charge with the cylinder upright. 

If	Then
A siphon tube is NOT present	Charge with the cylinder upside down. 

- Open refrigerant cylinders slowly.
- Charge the refrigerant in liquid form. Adding it in gas form may prevent normal operation.

**CAUTION**

When the refrigerant charging procedure is done or when pausing, close the valve of the refrigerant tank immediately. If the valve is NOT closed immediately, remaining pressure might charge additional refrigerant. **Possible consequence:** Incorrect refrigerant amount.

2.1.4 Electrical

**DANGER: RISK OF ELECTROCUTION**

- Turn OFF all power supply before removing the switch box cover, connecting electrical wiring or touching electrical parts.
- Disconnect the power supply for more than 10 minutes, and measure the voltage at the terminals of main circuit capacitors or electrical components before servicing. The voltage MUST be less than 50 V DC before you can touch electrical components. For the location of the terminals, see the wiring diagram.
- Do NOT touch electrical components with wet hands.
- Do NOT leave the unit unattended when the service cover is removed.

**WARNING**

If NOT factory installed, a main switch or other means for disconnection, having a contact separation in all poles providing full disconnection under overvoltage category III condition, MUST be installed in the fixed wiring.



WARNING

- ONLY use copper wires.
- Make sure the field wiring complies with the applicable legislation.
- All field wiring MUST be performed in accordance with the wiring diagram supplied with the product.
- NEVER squeeze bundled cables and make sure they do NOT come in contact with the piping and sharp edges. Make sure no external pressure is applied to the terminal connections.
- Make sure to install earth wiring. Do NOT earth the unit to a utility pipe, surge absorber, or telephone earth. Incomplete earth may cause electrical shock.
- Make sure to use a dedicated power circuit. NEVER use a power supply shared by another appliance.
- Make sure to install the required fuses or circuit breakers.
- Make sure to install an earth leakage protector. Failure to do so may cause electrical shock or fire.
- When installing the earth leakage protector, make sure it is compatible with the inverter (resistant to high frequency electric noise) to avoid unnecessary opening of the earth leakage protector.



WARNING

- After finishing the electrical work, confirm that each electrical component and terminal inside the electrical components box is connected securely.
- Make sure all covers are closed before starting up the unit.



CAUTION

- When connecting the power supply: connect the earth cable first, before making the current-carrying connections.
- When disconnecting the power supply: disconnect the current-carrying cables first, before separating the earth connection.
- The length of the conductors between the power supply stress relief and the terminal block itself MUST be as such that the current-carrying wires are tightened before the earth wire is in case the power supply is pulled loose from the stress relief.



NOTICE

Precautions when laying power wiring:



- Do NOT connect wiring of different thicknesses to the power terminal block (slack in the power wiring may cause abnormal heat).
- When connecting wiring which is the same thickness, do as shown in the figure above.
- For wiring, use the designated power wire and connect firmly, then secure to prevent outside pressure being exerted on the terminal board.
- Use an appropriate screwdriver for tightening the terminal screws. A screwdriver with a small head will damage the head and make proper tightening impossible.
- Over-tightening the terminal screws may break them.

Install power cables at least 1 meter away from televisions or radios to prevent interference. Depending on the radio waves, a distance of 1 meter may NOT be sufficient.



NOTICE

ONLY applicable if the power supply is three-phase, and the compressor has an ON/OFF starting method.

If there exists the possibility of reversed phase after a momentary black out and the power goes ON and OFF while the product is operating, attach a reversed phase protection circuit locally. Running the product in reversed phase can break the compressor and other parts.

3 Specific installer safety instructions

Always observe the following safety instructions and regulations.

General



WARNING

Make sure installation, servicing, maintenance, repair and applied materials follow the instructions from Daikin (including all documents listed in "Documentation set") and, in addition, comply with applicable legislation and are performed by qualified persons only. In Europe and areas where IEC standards apply, EN/IEC 60335-2-40 is the applicable standard.

Unit installation (see "16 Unit installation" [▶ 49])



WARNING

Installation shall be done by an installer, the choice of materials and installation shall comply with the applicable legislation. In Europe, EN378 is the applicable standard.



WARNING

The appliance using R32 refrigerant shall be stored so as to prevent mechanical damage and in a well-ventilated room without continuously operating ignition sources (e.g. open flames, an operating gas appliance, or an operating electric heater). The room size shall be as specified in the General safety precaution.



CAUTION

Appliance NOT accessible to the general public. Install it in a secured area, protected from easy access.

This unit is suitable for installation in a commercial, light industrial, household and residential environment.



WARNING

For units using the R32 refrigerant it is necessary to keep any required ventilation openings clear of obstructions.

Duct installation (see "16.2.2 Guidelines when installing the ducting" [▶ 54])



WARNING

Do NOT install operating ignition sources (example: open flames, an operating gas appliance or an operating electric heater) in the duct work.

**CAUTION**

- Make sure the installation of the duct does NOT exceed the setting range of the external static pressure for the unit. Refer to the technical datasheet of your model for the setting range.
- Make sure to install the canvas duct so vibrations are NOT transmitted to the duct or ceiling. Use a sound-absorbing material (insulation material) for the lining of the duct and apply vibration insulation rubber to the hanging bolts.
- When welding, make sure NOT to spatter onto the drain pan or the air filter.
- If the metal duct passes through a metal lath, wire lath or metal plate of the wooden structure, separate the duct and wall electrically.
- Install the outlet grille in a position where the airflow will not come into direct contact with people.
- Do NOT use booster fans in the duct. Use the function to adjust the fan rate setting automatically (see "20 Configuration" [▶ 73]).

Refrigerant piping installation (see "17 Piping installation" [▶ 59])**CAUTION**

- Incomplete flaring may cause refrigerant gas leakage.
- Do NOT re-use flares. Use new flares to prevent refrigerant gas leakage.
- Use flare nuts that are included with the unit. Using different flare nuts may cause refrigerant gas leakage.

**CAUTION**

Piping MUST be installed according to instructions given in "17 Piping installation" [▶ 59]. Only mechanical joints (e.g. braze+flare connections) that are compliant with the latest version of ISO14903 can be used.

**CAUTION**

Install the refrigerant piping or components in a position where they are unlikely to be exposed to any substance which may corrode components containing refrigerant, unless the components are constructed of materials that are inherently resistant to corrosion or are suitably protected against corrosion.

Electrical installation (see "18 Electrical installation" [▶ 64])**WARNING**

ALWAYS use multicore cable for power supply cables.

**WARNING**

- All wiring MUST be performed by an authorised electrician and MUST comply with the applicable national wiring regulation.
- Make electrical connections to the fixed wiring.
- All components procured on-site and all electrical construction MUST comply with the applicable legislation.



WARNING

- If the power supply has a missing or wrong N-phase, equipment might break down.
- Establish proper earthing. Do NOT earth the unit to a utility pipe, surge absorber, or telephone earth. Incomplete earthing may cause electrical shock.
- Install the required fuses or circuit breakers.
- Secure the electrical wiring with cable ties so that the cables do NOT come in contact with sharp edges or piping, particularly on the high-pressure side.
- Do NOT use taped wires, extension cords, or connections from a star system. They can cause overheating, electrical shock or fire.
- Do NOT install a phase advancing capacitor, because this unit is equipped with an inverter. A phase advancing capacitor will reduce performance and may cause accidents.



WARNING

Use an all-pole disconnection type breaker with at least 3 mm between the contact point gaps that provides full disconnection under overvoltage category III.



WARNING

If the supply cord is damaged, it MUST be replaced by the manufacturer, its service agent or similarly qualified persons in order to avoid a hazard.

For the user

4 User safety instructions

Always observe the following safety instructions and regulations.

4.1 General



WARNING

If you are NOT sure how to operate the unit, contact your installer.



WARNING

This appliance can be used by children aged from 8 years and above and persons with reduced physical, sensory or mental capabilities or lack of experience and knowledge if they have been given supervision or instruction concerning use of the appliance in a safe way and understand the hazards involved.

Children SHALL NOT play with the appliance.

Cleaning and user maintenance SHALL NOT be made by children without supervision.



WARNING

To prevent electrical shocks or fire:

- Do NOT rinse the unit.
- Do NOT operate the unit with wet hands.
- Do NOT place any objects containing water on the unit.



CAUTION

- Do NOT place any objects or equipment on top of the unit.
- Do NOT sit, climb or stand on the unit.

- Units are marked with the following symbol:



This means that electrical and electronic products may NOT be mixed with unsorted household waste. Do NOT try to dismantle the system yourself: dismantling the system, treatment of the refrigerant, of oil and of other parts MUST be done by an authorised installer and MUST comply with applicable legislation.

Units MUST be treated at a specialised treatment facility for reuse, recycling and recovery. By ensuring this product is disposed of correctly, you will help to prevent potential negative consequences for the environment and human health. For more information, contact your installer or local authority.

- Batteries are marked with the following symbol:



This means that the batteries may NOT be mixed with unsorted household waste. If a chemical symbol is printed beneath the symbol, this chemical symbol means that the battery contains a heavy metal above a certain concentration.

Possible chemical symbols are: Pb: lead (>0.004%).

Waste batteries MUST be treated at a specialised treatment facility for reuse. By ensuring waste batteries are disposed of correctly, you will help to prevent potential negative consequences for the environment and human health.

4.2 Instructions for safe operation



WARNING

- Do NOT modify, disassemble, remove, reinstall or repair the unit yourself as incorrect dismantling or installation may cause an electrical shock or fire. Contact your dealer.
- In case of accidental refrigerant leaks, make sure there are no naked flames. The refrigerant itself is entirely safe and non-toxic. R410A is a non-combustible refrigerant, and R32 is a mildly flammable refrigerant, but they will generate a toxic gas when they accidentally leak into a room where combustible air from fan heaters, gas cookers, etc. is present. Always have qualified service personnel confirm that the point of leakage has been repaired or corrected before resuming operation.



CAUTION

- NEVER touch the internal parts of the controller.
- Do NOT remove the front panel. Some parts inside are dangerous to touch and appliance problems may happen. For checking and adjusting the internal parts, contact your dealer.



WARNING

This unit contains electrical and hot parts.



WARNING

Before operating the unit, be sure the installation has been carried out correctly by an installer.



CAUTION

It is unhealthy to expose your body to the air flow for a long time.



CAUTION

To avoid oxygen deficiency, ventilate the room sufficiently if equipment with burner is used together with the system.



CAUTION

Do NOT operate the system when using a room fumigation-type insecticide. Chemicals could collect in the unit, and endanger the health of people who are hypersensitive to chemicals.



WARNING

NEVER touch the air outlet or the horizontal blades while the swing flap is in operation. Fingers may become caught or the unit may break down.



CAUTION

NEVER expose little children, plants or animals directly to the airflow.



WARNING

Do NOT place a flammable spray bottle near the air conditioner and do NOT use sprays near the unit. Doing so may result in a fire.

**WARNING**

For units using the R32 refrigerant it is necessary to keep any required ventilation openings clear of obstructions.

Maintenance and service (see "10 Maintenance and service" [▶ 33])

**CAUTION: Pay attention to the fan!**

It is dangerous to inspect the unit while the fan is running. Make sure to turn OFF the main switch before executing any maintenance task.

**CAUTION**

Do NOT insert fingers, rods or other objects into the air inlet or outlet. When the fan is rotating at high speed, it will cause injury.

**WARNING**

NEVER replace a fuse with a fuse of a wrong ampere ratings or other wires when a fuse blows out. Use of wire or copper wire may cause the unit to break down or cause a fire.

**CAUTION**

After a long use, check the unit stand and fitting for damage. If damaged, the unit may fall and result in injury.

**CAUTION**

Before accessing terminal devices, make sure to interrupt all power supply.

**DANGER: RISK OF ELECTROCUTION**

To clean the air conditioner or air filter, be sure to stop operation and turn all power supplies OFF. Otherwise, an electrical shock and injury may result.

**WARNING**

Be careful with ladders when working in high places.



DANGER: RISK OF ELECTROCUTION

Disconnect the power supply for more than 10 minutes, and measure the voltage at the terminals of main circuit capacitors or electrical components before servicing. The voltage **MUST** be less than 50 V DC before you can touch electrical components. For the location of the terminals, see the warning label for persons performing service and maintenance.



CAUTION

Turn off the unit before cleaning the unit exterior, air filter and suction grille.



WARNING

Do **NOT** let the indoor unit get wet. **Possible consequence:** Electrical shock or fire.

[About the refrigerant \(see "10.5 About the refrigerant" \[▶ 35\]\)](#)



WARNING: MILDLY FLAMMABLE MATERIAL

The R32 refrigerant (if applicable) in this unit is mildly flammable. Refer to the outdoor unit specifications for the type of refrigerant to be used.



WARNING

The appliance using R32 refrigerant shall be stored so as to prevent mechanical damage and in a well-ventilated room without continuously operating ignition sources (e.g. open flames, an operating gas appliance, or an operating electric heater). The room size shall be as specified in the General safety precaution.



WARNING

- Do **NOT** pierce or burn refrigerant cycle parts.
- Do **NOT** use cleaning materials or means to accelerate the defrosting process other than those recommended by the manufacturer.
- Be aware that the refrigerant inside the system is odourless.

**WARNING**

- R410A is a non-combustible refrigerant, and R32 is a mildly flammable refrigerant; they normally do NOT leak. If the refrigerant leaks in the room and comes into contact with fire from a burner, a heater, or a cooker, this may result in a fire (in case of R32), or the formation of a harmful gas.
- Turn OFF any combustible heating devices, ventilate the room, and contact the dealer from where you purchased the unit.
- Do NOT use the unit until a service person confirms that the part from which the refrigerant leaked has been repaired.

Troubleshooting (see "11 Troubleshooting" [▶ 37])

**WARNING**

Stop operation and shut OFF the power if anything unusual occurs (burning smells etc.).

Leaving the unit running under such circumstances may cause breakage, electrical shock or fire. Contact your dealer.

5 About the system



WARNING

- Do NOT modify, disassemble, remove, reinstall or repair the unit yourself as incorrect dismantling or installation may cause an electrical shock or fire. Contact your dealer.
- In case of accidental refrigerant leaks, make sure there are no naked flames. The refrigerant itself is entirely safe and non-toxic. R410A is a non-combustible refrigerant, and R32 is a mildly flammable refrigerant, but they will generate a toxic gas when they accidentally leak into a room where combustible air from fan heaters, gas cookers, etc. is present. Always have qualified service personnel confirm that the point of leakage has been repaired or corrected before resuming operation.



NOTICE

Do NOT use the system for other purposes. In order to avoid any quality deterioration, do NOT use the unit for cooling precision instruments, food, plants, animals, or works of art.



NOTICE

For future modifications or expansions of your system:

A full overview of allowable combinations (for future system extensions) is available in technical engineering data and should be consulted. Contact your installer to receive more information and professional advice.

5.1 System layout



INFORMATION

The following figures are just examples and may NOT completely match your system layout.

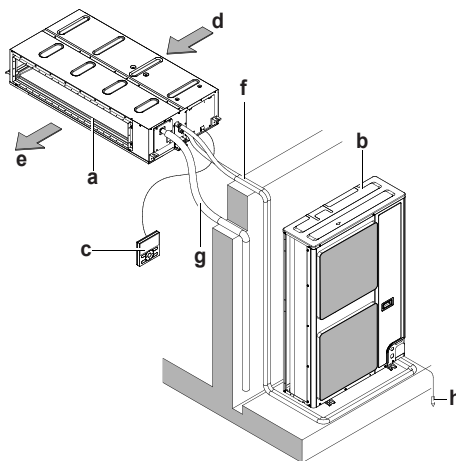

- a Indoor unit
- b Outdoor unit
- c User interface
- d Suction air
- e Discharge air
- f Refrigerant piping + interconnection cable
- g Drain pipe
- h Earth wiring

5.2 Information requirements for fan coil units

Item	Symbol	Value	Unit		
Cooling capacity (sensible)	$P_{\text{rated,c}}$	A	kW		
Cooling capacity (latent)	$P_{\text{rated,c}}$	B	kW		
Heating capacity	$P_{\text{rated,h}}$	C	kW		
Total electric power input	P_{elec}	D	kW		
Sound power level (cooling)	L_{WA}	E	dB(A)		
Sound power level (heating)	L_{WA}	F	dB(A)		
Contact details: DAIKIN INDUSTRIES CZECH REPUBLIC s.r.o. U Nové Hospody 1/1155, 301 00 Plzeň Skvrňany, Czech Republic					
	A	B	C	D	E
FDA125A	7.83	4.27	13.50	0.35	66

6 User interface



CAUTION

- NEVER touch the internal parts of the controller.
- Do NOT remove the front panel. Some parts inside are dangerous to touch and appliance problems may happen. For checking and adjusting the internal parts, contact your dealer.



NOTICE

Do NOT wipe the controller operation panel with benzine, thinner, chemical dust cloth, etc. The panel may get discoloured or the coating peeled off. If it is heavily dirty, soak a cloth in water-diluted neutral detergent, squeeze it well and wipe the panel clean. Wipe it with another dry cloth.



NOTICE

NEVER press the button of the user interface with a hard, pointed object. The user interface may be damaged.



NOTICE

NEVER pull or twist the electric wire of the user interface. It may cause the unit to malfunction.

This operation manual offers a non-exhaustive overview of the main functions of the system.

For more information about the user interface, see the operation manual of the installed user interface.

7 Before operation

**CAUTION**

See "4 User safety instructions" [▶ 20] to acknowledge all related safety instructions.

**NOTICE**

Do NOT place items which might be damaged by moisture under the indoor unit. Condensation may form if the humidity is above 80%, if the drain outlet is blocked or the filter is polluted.

**NOTICE**

Turn ON the power 6 hours before operation in order to have power running to the crankcase heater and to protect the compressor.

This operation manual is for the following systems with standard control. Before initiating operation, contact your dealer for the operation that corresponds to your system type and mark. If your installation has a customised control system, ask your dealer for the operation that corresponds to your system.

8 Operation

8.1 Operation range

For combination with R410A outdoor unit			
Outdoor units	Temperature	Cooling	Heating
RZQ250	Outdoor	-5~46°C DB	-15~15°C WB
	Indoor	14~28°C WB	10~27°C DB
RZQG125	Outdoor	-15~50°C DB	-20~15.5°C WB
	Indoor	12~28°C WB	10~27°C DB
RZQSG125	Outdoor	-15~46°C DB	-15~15.5°C WB
	Indoor	14~28°C WB	10~27°C DB
RR125	Outdoor	-15~46°C DB	—
	Indoor	12~28°C WB	—
RQ125	Outdoor	-5~46°C DB	-10~15°C WB
	Indoor	12~28°C WB	10~27°C DB
Indoor humidity		≤80% ^(a)	

^(a) To avoid condensation and water dripping out of the unit. If the temperature or the humidity is beyond these conditions, safety devices may be put in action and the air conditioner may not operate.

For combination with R32 outdoor unit			
Outdoor units	Temperature	Cooling	Heating
RZAG125	Outdoor	-20~52°C DB	-20~24°C DB -20~18°C WB
	Indoor	17~38°C DB 12~28°C WB	10~27°C DB
RZASG125	Outdoor	-15~46°C DB	-15~21°C DB -15~15.5°C WB
	Indoor	20~38°C DB 14~28°C WB	10~27°C DB
Indoor humidity		≤80% ^(a)	

^(a) To avoid condensation and water dripping out of the unit. If the temperature or the humidity is beyond these conditions, safety devices may be put in action and the air conditioner may not operate.

8.2 About operation modes







INFORMATION

Depending on the installed system, some operation modes will not be available.



- The air flow rate may adjust itself depending on the room temperature or the fan may stop immediately. This is not a malfunction.
- If the main power supply is turned off during operation, operation will restart automatically after the power turns back on again.
- **Setpoint.** Target temperature for the Cooling, Heating, and Auto operation modes.
- **Setback.** A function that keeps the room temperature in a specific range when the system is turned off (by the user, the schedule function, or the OFF timer).

8.2.1 Basic operation modes

The indoor unit can operate in various operation modes.

Icon	Operation mode
	Cooling. In this mode, cooling will be activated as required by the setpoint, or by Setback operation.
	Heating. In this mode, heating will be activated as required by the setpoint, or by Setback operation.
	Fan only. In this mode, air circulates without heating or cooling.
	Auto. In Auto mode, the indoor unit automatically switches between heating and cooling mode, as required by the setpoint.

8.2.2 Special heating operation modes

Operation	Description
Defrost	<p>To prevent a loss of heating capacity due to frost accumulation in the outdoor unit, the system will automatically switch to defrost operation.</p> <p>During defrost operation, the indoor unit fan will stop operation, and the following icon will appear on the home screen:</p>  <p>The system will resume normal operation after approximately 6 to 8 minutes.</p>
Hot start	<p>During hot start, the indoor unit fan will stop operation, and the following icon will appear on the home screen:</p> 

8.3 To operate the system



INFORMATION

For setting of the operation mode or other settings, see the reference guide or operation manual of the user interface.

9 Energy saving and optimum operation



CAUTION

NEVER expose little children, plants or animals directly to the airflow.



NOTICE

Do NOT place objects below the indoor and/or outdoor unit that may get wet. Otherwise condensation on the unit or refrigerant pipes, air filter dirt or drain blockage may cause dripping, and objects under the unit may get dirty or damaged.



WARNING

Do NOT place a flammable spray bottle near the air conditioner and do NOT use sprays near the unit. Doing so may result in a fire.



WARNING

For units using the R32 refrigerant it is necessary to keep any required ventilation openings clear of obstructions.

Observe the following precautions to ensure the system operates properly.

- Prevent direct sunlight from entering a room during cooling operation by using curtains or blinds.
- Make sure the area is well ventilated. Do NOT block any ventilation openings.
- Ventilate often. Extended use requires special attention to ventilation.
- Keep doors and windows closed. If the doors and windows remain open, air will flow out of your room causing a decrease in the cooling or heating effect.
- Be careful NOT to cool or heat too much. To save energy, keep the temperature setting at a moderate level.
- NEVER place objects near the air inlet or the air outlet of the unit. Doing so may cause a reduced heating/cooling effect or stop operation.
- Turn off the main power supply switch to the unit when the unit is NOT used for longer periods of time. If the main power supply switch is on, the unit consumes electricity. Before restarting the unit, turn on the main power supply switch 6 hours before operation to ensure smooth running.
- When the display shows  (time to clean the air filter), clean the filters (see "10.2.1 To clean the air filter" [▶ 33]).
- Condensation may form if the humidity is above 80% or if the drain outlet gets blocked.
- Adjust the room temperature properly for a comfortable environment. Avoid excessive heating or cooling. Notice that it may take some time for the room temperature to reach the set temperature. Consider using the timer setting options.
- Adjust the air flow direction to avoid cool air from gathering on the floor or warm air against the ceiling. (Up during cooling or dry operation to the ceiling and down during heating operation.)
- Avoid direct air flow to room inhabitants.

10 Maintenance and service

10.1 Precautions for maintenance and service



CAUTION

See "4 User safety instructions" [▶ 20] to acknowledge all related safety instructions.



NOTICE

NEVER inspect or service the unit by yourself. Ask a qualified service person to perform this work. However, as end user, you may clean the air filter and air outlet.



NOTICE

Maintenance MUST be done by an authorised installer or service agent.

We recommend performing maintenance at least once a year. However, applicable legislation might require shorter maintenance intervals.



NOTICE

Do NOT wipe the controller operation panel with benzene, thinner, chemical dust cloth, etc. The panel may get discoloured or the coating peeled off. If it is heavily dirty, soak a cloth in water-diluted neutral detergent, squeeze it well and wipe the panel clean. Wipe it with another dry cloth.

10.2 Cleaning the air filter and air outlet



CAUTION

Turn off the unit before cleaning the air filter and air outlet.



NOTICE

- Do NOT use gasoline, benzene, thinner polishing powder or liquid insecticide.
Possible consequence: Discoloration and deformation.
- Do NOT use water or air of 50°C or higher. **Possible consequence:** Discoloration and deformation.

10.2.1 To clean the air filter

When to clean the air filter:

- Rule of thumb: Clean every 6 months. If the air in the room is extremely contaminated, increase the cleaning frequency.
- Depending on the settings, the user interface can display the **TIME TO CLEAN AIR FILTER** notification. Clean the air filter when the notification is displayed.
- If the dirt becomes impossible to clean, change the air filter (= optional equipment).

How to clean the air filter:

- 1 Remove the air filters by pulling their cloth upward (in case of rear suction) or backward (in case of bottom suction).

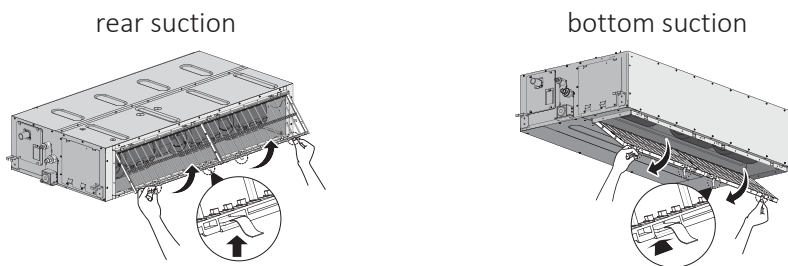

- 2 Clean the air filter. Use a vacuum cleaner or wash with water. If the air filter is very dirty, use a soft brush and neutral detergent.

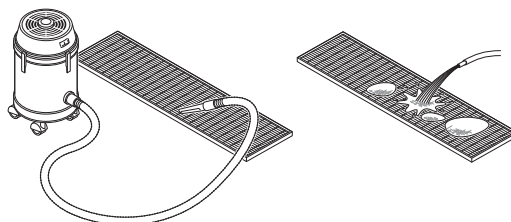

- 3 Dry the air filter in the shadow.
- 4 Reattach the air filter. Align the 2 hanger brackets and push the 2 clips in their place and pull the cloth if necessary.

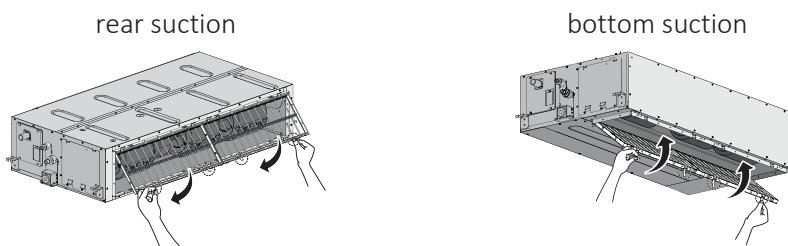

- 5 Confirm that 4 hangers are fixed.
- 6 In case of bottom suction, close the air inlet grille.
- 7 Turn ON the power.
- 8 Press the **FILTER SIGN RESET** button.

Result: The **TIME TO CLEAN AIR FILTER** notification disappears from the user interface.

10.2.2 To clean the air outlet



WARNING
Do NOT let the indoor unit get wet. **Possible consequence:** Electrical shock or fire.

Clean with a soft cloth. If it is difficult to remove stains, use water or a neutral detergent.

10.3 Maintenance before a long stop period

E.g., at the end of the season.

- Let the indoor units run in fan only operation for about half a day in order to dry the interior of the units.

- Turn off the power. The user interface display disappears. When the main power is turned on, the air conditioner will use some power, even if it is not operating.
- Clean the air filter and the casing of the indoor unit (see "[10.2 Cleaning the air filter and air outlet](#)" [▶ 33]). Make sure to install cleaned air filters back in the same position.
- Remove the batteries from the user interface (if applicable).

10.4 Maintenance after a long stop period

E.g., at the beginning of the season.

- Check and remove everything that might be blocking inlet and outlet vents of indoor units and outdoor units.
- Check if the earth is connected properly.
- Check if there is somewhere a broken wire. Contact your dealer in case of problems.
- Clean the air filter and the casing of the indoor unit (see "[10.2 Cleaning the air filter and air outlet](#)" [▶ 33]). Make sure to install cleaned air filters back in the same position.
- Turn on the power at least 6 hours before operating the unit in order to ensure smoother operation. As soon as the power is turned on, the user interface display appears.
- Insert batteries in the user interface (if applicable).

10.5 About the refrigerant

This product contains fluorinated greenhouse gases. Do NOT vent gases into the atmosphere.

Refrigerant type: R32

Global warming potential (GWP) value: 675

Refrigerant type: R410A

Global warming potential (GWP) value: 2087.5



NOTICE

Applicable legislation on **fluorinated greenhouse gases** requires that the refrigerant charge of the unit is indicated both in weight and CO₂ equivalent.

Formula to calculate the quantity in CO₂ equivalent tonnes: GWP value of the refrigerant × total refrigerant charge [in kg]/1000

Contact your installer for more information.



WARNING: MILDLY FLAMMABLE MATERIAL

The R32 refrigerant (if applicable) in this unit is mildly flammable. Refer to the outdoor unit specifications for the type of refrigerant to be used.



WARNING

The appliance using R32 refrigerant shall be stored so as to prevent mechanical damage and in a well-ventilated room without continuously operating ignition sources (e.g. open flames, an operating gas appliance, or an operating electric heater). The room size shall be as specified in the General safety precaution.



WARNING

- Do NOT pierce or burn refrigerant cycle parts.
- Do NOT use cleaning materials or means to accelerate the defrosting process other than those recommended by the manufacturer.
- Be aware that the refrigerant inside the system is odourless.



WARNING

- R410A is a non-combustible refrigerant, and R32 is a mildly flammable refrigerant; they normally do NOT leak. If the refrigerant leaks in the room and comes into contact with fire from a burner, a heater, or a cooker, this may result in a fire (in case of R32), or the formation of a harmful gas.
- Turn OFF any combustible heating devices, ventilate the room, and contact the dealer from where you purchased the unit.
- Do NOT use the unit until a service person confirms that the part from which the refrigerant leaked has been repaired.

11 Troubleshooting

If one of the following malfunctions occur, take the measures shown below and contact your dealer.



WARNING

Stop operation and shut OFF the power if anything unusual occurs (burning smells etc.).

Leaving the unit running under such circumstances may cause breakage, electrical shock or fire. Contact your dealer.

The system **MUST** be repaired by a qualified service person.

Malfunction	Measure
If a safety device such as a fuse, a circuit breaker or a residual current device frequently actuates or the ON/OFF switch does NOT function properly.	Turn OFF all main power supply switches to the unit.
If water leaks from the unit.	Stop operation.
The operation switch does NOT function properly.	Turn OFF the power supply.
If the user interface displays	Notify your installer and report the error code. To display an error code see the reference guide of the user interface.

Malfunction	Measure
If the system does not operate at all.	<ul style="list-style-type: none"> ▪ Check if there is no power failure. Wait until power is restored. If a power failure occurs during operation, the system automatically restarts immediately after power is restored. ▪ Check if no fuse has blown or breaker is activated. Change the fuse or reset the breaker if necessary.
The system stops immediately after starting operation.	<ul style="list-style-type: none"> ▪ Check if air inlet or outlet of outdoor or indoor unit is not blocked by obstacles. Remove any obstacles and make sure the air can flow freely. ▪ Check if the air filter is clogged (see "10.2.1 To clean the air filter" [▶ 33]).

Malfunction	Measure
The system operates but cooling or heating is insufficient.	<ul style="list-style-type: none"> ▪ Check if air inlet or outlet of outdoor or indoor unit is not blocked by obstacles. Remove any obstacles and make sure the air can flow freely. ▪ Check if the air filter is clogged (see "10.2.1 To clean the air filter" [▶ 33]). ▪ Check the temperature setting. Refer to the manual of the user interface. ▪ Check if the fan speed setting is set to low speed. Refer to the manual of the user interface. ▪ Check if the air flow angle is proper. Refer to the manual of the user interface. ▪ Check for open doors or windows. Close doors and windows to prevent wind from coming in. ▪ Check if direct sunlight enters the room. Use curtains or blinds. ▪ Check if there are too many occupants in the room during cooling operation. Check if the heat source of the room is excessive. ▪ If the heat source of the room is excessive (when cooling). Cooling effect decreases if heat gain of the room is too large.
Operation stops suddenly. (Operation lamp blinks.)	<ul style="list-style-type: none"> ▪ Check if the air filter is clogged (see "10.2.1 To clean the air filter" [▶ 33]). ▪ Check if air inlet or outlet of outdoor or indoor unit is not blocked by obstacles. Remove any obstacles, turn the breaker OFF and back ON. If the lamp still blinks, contact your dealer. ▪ Check if all indoor units connected to outdoor unit in the multi-system are operating in the same mode.
An abnormal function happens during operation.	<ul style="list-style-type: none"> ▪ The air conditioner may malfunction because of lightning or radio waves. Turn the breaker OFF and back ON.

If after checking all above items, it is impossible to fix the problem yourself, contact your installer and state the symptoms, the complete model name of the unit (with manufacturing number if possible) and the installation date (possibly listed on the warranty card).

11.1 Symptoms that are NOT system malfunctions

The following symptoms are NOT system malfunctions:

11.1.1 Symptom: The system does not operate

- The air conditioner does not start immediately after the ON/OFF button on the user interface is pressed. If the operation lamp lights, the air conditioner is in normal condition. It does not restart immediately because one of its safety

devices actuates to prevent the air conditioner from being overloaded. The air conditioner will turn on again automatically after 3 minutes.

- The air conditioner does not start immediately after the power supply is turned on. Wait 1 minute until the microcomputer is prepared for operation.
- The air conditioner does not restart immediately when the temperature setting button is returned to its former position after pushing. It does not restart immediately because one of its safety devices actuates to prevent the air conditioner from being overloaded. The air conditioner will turn on again automatically after 3 minutes.
- The outdoor unit has stopped. This is because the room temperature has reached the set temperature. The unit switches to fan operation. " " (external control icon) is displayed on the user interface and the actual operation is different from the user interface setting. For multi-split models, the microcomputer executes the following control depending on the operation mode of other indoor units.
- The fan speed is different from the setting. Pressing the fan speed control button does not change the fan speed. When the room temperature reaches the set temperature in heating mode or the unit's maximum capacity is reached, the outdoor unit will stop operation and the indoor unit will operate in fan only mode (low fan speed). In case of multi-split, the indoor unit alternately operates in fan stop mode and fan only mode (LL= low fan speed). This is to prevent the cool air from being blown directly onto anyone present in the room.

11.1.2 Symptom: White mist comes out of a unit (Indoor unit)

- When humidity is high during cooling operation (in oily and dusty places). If the interior of an indoor unit is extremely contaminated, the temperature distribution inside a room becomes uneven. It is necessary to clean the interior of the indoor unit. Ask your dealer for details on cleaning the unit. This operation requires a qualified service person.
- When the air conditioner is changed over to heating operation after defrost operation. Moisture generated by defrost becomes steam and exits.

11.1.3 Symptom: White mist comes out of a unit (Indoor unit, outdoor unit)

When the system is changed over to heating operation after defrost operation. Moisture generated by defrost becomes steam and is exhausted.

11.1.4 Symptom: The user interface reads "U4" or "U5" and stops, but then restarts after a few minutes

This is because the user interface is intercepting noise from electric appliances other than the air conditioner. The noise prevents communication between the units, causing them to stop. Operation automatically restarts when the noise ceases. A power reset may help to remove this error.

11.1.5 Symptom: Noise of air conditioners (Indoor unit)

- A "pishi-pishi" squeaking sound is heard when the system stops after heating operation. Expansion and contraction of plastic parts caused by temperature change make this noise.

11.1.6 Symptom: Noise of air conditioners (Indoor unit, outdoor unit)

- A continuous low hissing sound is heard when the system is in cooling or defrost operation. This is the sound of refrigerant gas flowing through both indoor and outdoor units.
- A hissing sound which is heard at the start or immediately after stopping operation or defrost operation. This is the noise of refrigerant caused by flow stop or flow change.

11.1.7 Symptom: Dust comes out of the unit

When the unit is used for the first time in a long time. This is because dust has gotten into the unit.

11.1.8 Symptom: The units can give off odours

The unit can absorb the smell of rooms, furniture, cigarettes, etc., and then emit it again.

12 Relocation

Contact your dealer to remove and reinstall the entire unit. Moving units requires technical expertise.

13 Disposal



NOTICE

Do NOT try to dismantle the system yourself: dismantling of the system, treatment of the refrigerant, oil and other parts **MUST** comply with applicable legislation. Units **MUST** be treated at a specialised treatment facility for reuse, recycling and recovery.

For the installer

14 About the box

Keep the following in mind:

- At delivery, the unit **MUST** be checked for damage and completeness. Any damage or missing parts **MUST** be reported immediately to the claims agent of the carrier.
- Bring the packed unit as close as possible to its final installation position to prevent damage during transport.
- Prepare in advance the path along which you want to bring the unit to its final installation position.
- When handling the unit, take into account the following:



Fragile, handle the unit with care.



Keep the unit upright in order to avoid damage.

14.1 Indoor unit



INFORMATION

The following figures are just examples and may NOT completely match your system layout.



WARNING: MILDLY FLAMMABLE MATERIAL

The R32 refrigerant (if applicable) in this unit is mildly flammable. Refer to the outdoor unit specifications for the type of refrigerant to be used.

14.1.1 To unpack and handle the unit

Use a sling of soft material or protective plates together with a rope when lifting the unit in order to avoid damage or scratches to the unit.

- 1 Lift the unit by holding on to the hanger brackets without exerting any pressure on other parts, especially on refrigerant piping, drain piping and other resin parts.

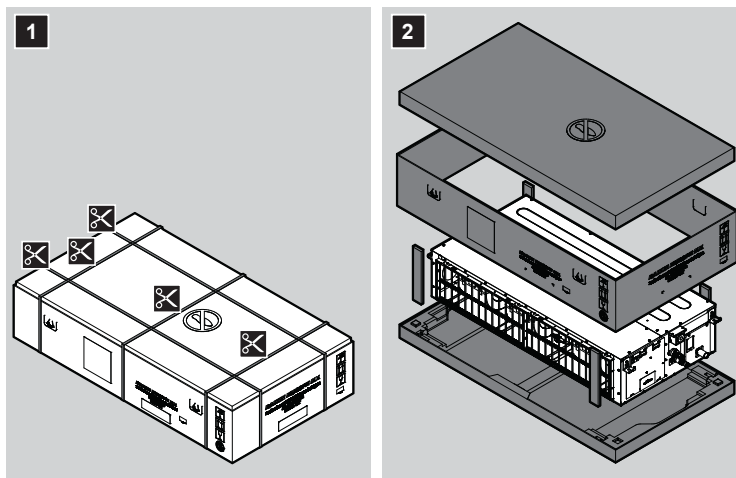

14.1.2 To remove the accessories from the indoor unit

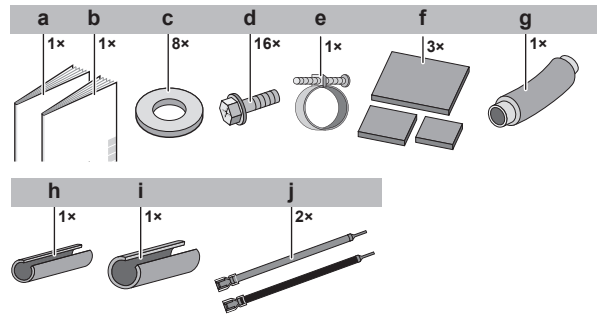

- a** Installation and operation manual
- b** General safety precautions
- c** Washers for hanger bracket
- d** Screws for duct flanges
- e** Metal clamp
- f** Sealing pads: Large (drain pipe), medium 1 (gas pipe), medium 2 (liquid pipe)
- g** Drain hose
- h** Insulation piece: Small (liquid pipe)
- i** Insulation piece: Large (gas pipe)
- j** Wire for common power supply

15 About the units and options

In this chapter

15.1	Identification.....	46
15.1.1	Identification label: Indoor unit.....	46
15.2	About the indoor unit.....	46
15.3	System layout.....	47
15.4	Combining units and options.....	47
15.4.1	Possible options for the indoor unit.....	48

15.1 Identification

NOTICE

When installing or servicing several units at the same time, make sure NOT to switch the service panels between different models.

15.1.1 Identification label: Indoor unit

Location

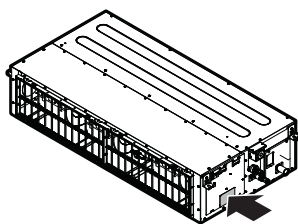

15.2 About the indoor unit

For combination with R410A outdoor unit			
Outdoor units	Temperature	Cooling	Heating
RZQ250	Outdoor	-5~46°C DB	-15~15°C WB
	Indoor	14~28°C WB	10~27°C DB
RZQG125	Outdoor	-15~50°C DB	-20~15.5°C WB
	Indoor	12~28°C WB	10~27°C DB
RZQSG125	Outdoor	-15~46°C DB	-15~15.5°C WB
	Indoor	14~28°C WB	10~27°C DB
RR125	Outdoor	-15~46°C DB	—
	Indoor	12~28°C WB	—
RQ125	Outdoor	-5~46°C DB	-10~15°C WB
	Indoor	12~28°C WB	10~27°C DB
Indoor humidity		≤80% ^(a)	

^(a) To avoid condensation and water dripping out of the unit. If the temperature or the humidity is beyond these conditions, safety devices may be put in action and the air conditioner may not operate.

For combination with R32 outdoor unit			
Outdoor units	Temperature	Cooling	Heating
RZAG125	Outdoor	-20~52°C DB	-20~24°C DB -20~18°C WB
	Indoor	17~38°C DB 12~28°C WB	10~27°C DB
RZASG125	Outdoor	-15~46°C DB	-15~21°C DB -15~15.5°C WB
	Indoor	20~38°C DB 14~28°C WB	10~27°C DB
Indoor humidity		≤80% ^(a)	

^(a) To avoid condensation and water dripping out of the unit. If the temperature or the humidity is beyond these conditions, safety devices may be put in action and the air conditioner may not operate.

15.3 System layout



INFORMATION

The following figures are just examples and may NOT completely match your system layout.

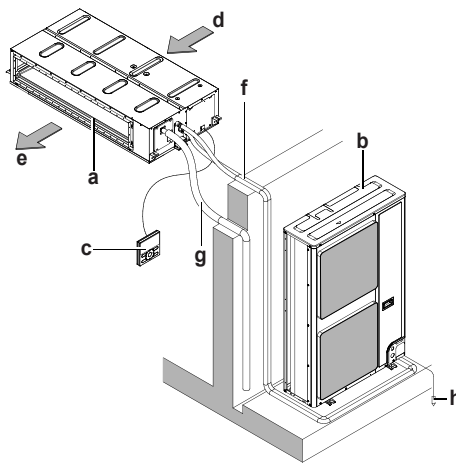

- a Indoor unit
- b Outdoor unit
- c User interface
- d Suction air
- e Discharge air
- f Refrigerant piping + interconnection cable
- g Drain pipe
- h Earth wiring

15.4 Combining units and options



INFORMATION

Certain options may NOT be available in your country.

15.4.1 Possible options for the indoor unit

Make sure you have the following mandatory options:

- User interface: Wired or wireless
- Air inlet panel and canvas connection for the air inlet panel (in case of bottom suction).

16 Unit installation



WARNING

Installation shall be done by an installer, the choice of materials and installation shall comply with the applicable legislation. In Europe, EN378 is the applicable standard.

In this chapter

16.1	Preparing the installation site	49
16.1.1	Installation site requirements of the indoor unit	49
16.2	Mounting the indoor unit	51
16.2.1	Guidelines when installing the indoor unit	51
16.2.2	Guidelines when installing the ducting	54
16.2.3	Guidelines when installing the drain piping	55

16.1 Preparing the installation site

Choose an installation location with sufficient space to transport the unit in and out of the site.

Do NOT install the unit in places often used as work place. In case of construction works (e.g. grinding works) where a lot of dust is created, the unit MUST be covered.



WARNING

The appliance using R32 refrigerant shall be stored so as to prevent mechanical damage and in a well-ventilated room without continuously operating ignition sources (e.g. open flames, an operating gas appliance, or an operating electric heater). The room size shall be as specified in the General safety precaution.

16.1.1 Installation site requirements of the indoor unit



INFORMATION

Also read the general installation site requirements. See the "[2 General safety precautions](#)" [▶ 7] chapter.



INFORMATION

The sound pressure level is less than 70 dBA.



CAUTION

Appliance NOT accessible to the general public. Install it in a secured area, protected from easy access.

This unit is suitable for installation in a commercial, light industrial, household and residential environment.



WARNING

For units using the R32 refrigerant it is necessary to keep any required ventilation openings clear of obstructions.

Do NOT install the unit in the following places:

- In places where a mineral oil mist, spray or vapour may be present in the atmosphere. Plastic parts may deteriorate and fall off or cause water leakage.

It is NOT recommended to install the unit in the following places because it may shorten the life of the unit:

- Where the voltage fluctuates a lot
- In vehicles or vessels
- Where acidic or alkaline vapour is present



NOTICE

The equipment described in this manual may cause electronic noise generated from radio-frequency energy. The equipment complies to specifications that are designed to provide reasonable protection against such interference. However, there is no guarantee that interference will NOT occur in a particular installation.

It is therefore recommended to install the equipment and electric wires in such a way that they keep a proper distance from stereo equipment, personal computers, etc.

In places with weak reception, keep distances of 3 m or more to avoid electromagnetic interference of other equipment and use conduit tubes for power and transmission lines.

- Take care that in the event of a water leak, water cannot cause any damage to the installation space and surroundings.
- Choose a location where the operation noise or the hot/cold air discharged from the unit will not disturb anyone and the location is selected according the applicable legislation.
- **Drainage.** Make sure condensation water can be evacuated properly.
- **Paper pattern for installation** (accessory). Use the paper pattern when selecting the installation location. It contains the dimensions of the unit and the locations of suspension bolts, piping outlet, drain piping outlet and electric wiring inlet.
- **Ceiling insulation.** When conditions in the ceiling exceed 30°C and a relative humidity of 80%, or when fresh air is inducted into the ceiling, then additional insulation is required (minimum 10 mm thickness, polyethylene foam).
- **Protective guards.** Make sure to install protective guards on the suction and discharge side to prevent somebody from touching the fan blades or heat exchanger.
- Use **suspension bolts** for installation.
- **Spacing.** Mind the following requirements:

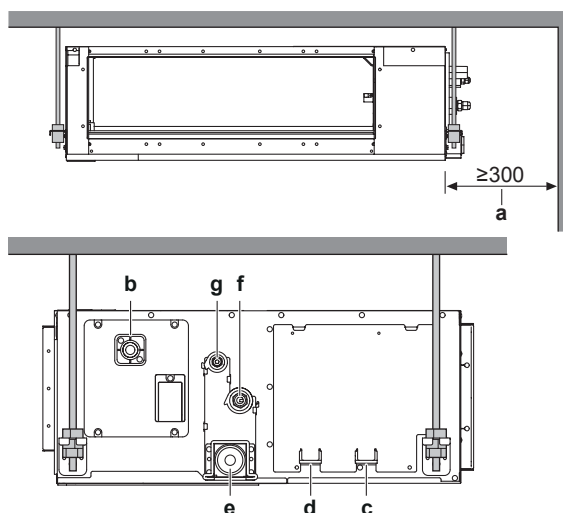

- a Service space
- b Drain pipe
- c Power supply wiring port
- d Transmission wiring port
- e Maintenance drain outlet
- f Gas pipe
- g Liquid pipe

▪ **Installation options:**

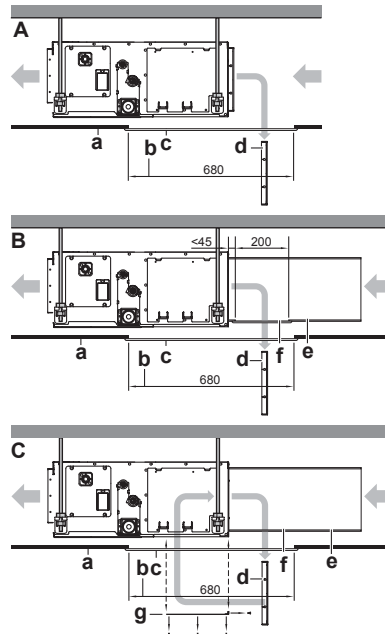

- A Standard rear suction
- B Installation with rear duct and duct service opening
- C Installation with rear duct, no duct service opening
- a Ceiling surface
- b Ceiling opening
- c Service access panel (field supply)
- d Air filter
- e Air inlet filter
- f Duct service opening
- g Interchangeable plate

16.2 Mounting the indoor unit

16.2.1 Guidelines when installing the indoor unit



INFORMATION

Optional equipment. When installing optional equipment, also read the installation manual of the optional equipment. Depending on the field conditions, it might be easier to install the optional equipment first.

- **In case of installation with duct, but no duct service opening.** Modify the position of the air filters.

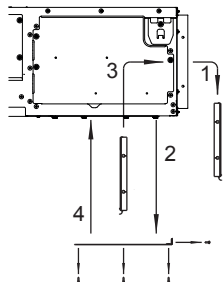

- 1 Remove the air filter(s) from the outside of the unit.
 - 2 Remove the interchangeable plate.
 - 3 Install the air filter(s) on the inside of the unit.
 - 4 Reinstall the interchangeable plate.
- When installing an air inlet duct, select fixing screws that stick out 5 mm on the inside of the flange to protect the air filter from damage during maintenance of the filter.

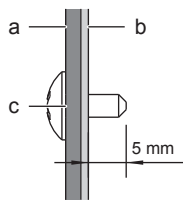

- a Air inlet duct
- b Inside of the flange
- c Fixing screw

- **Ceiling strength.** Check whether the ceiling is strong enough to support the weight of the unit. If there is a risk, reinforce the ceiling before installing the unit.
- **Installation options:**

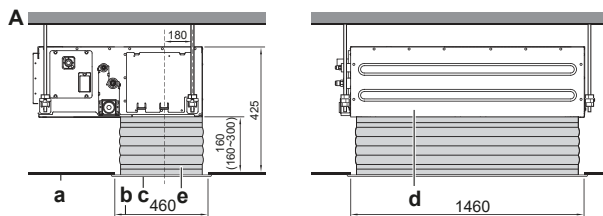

- A Mounting the air inlet with a canvas connection
- a Ceiling surface
- b Ceiling opening
- c Air inlet panel (field supply)
- d Indoor unit (back side)
- e Canvas connection for air inlet panel (field supply)



INFORMATION

The unit can be used with bottom suction by replacing the interchangeable plate by the air filter holding plate.

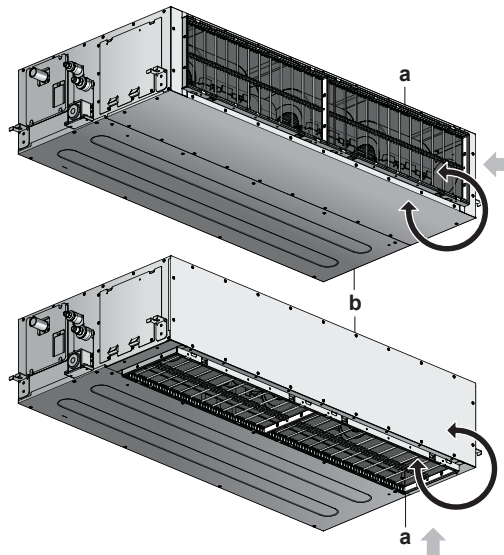

- a Air filter holding plate with air filter(s)
- b Interchangeable plate

- **Suspension bolts.** Use M10 suspension bolts for installation. Attach the hanger bracket to the suspension bolt. Fix it securely using a nut and washer from the upper and lower sides of the hanger bracket.
- **Ceiling opening size.** Make sure the ceiling opening is within the following limits:

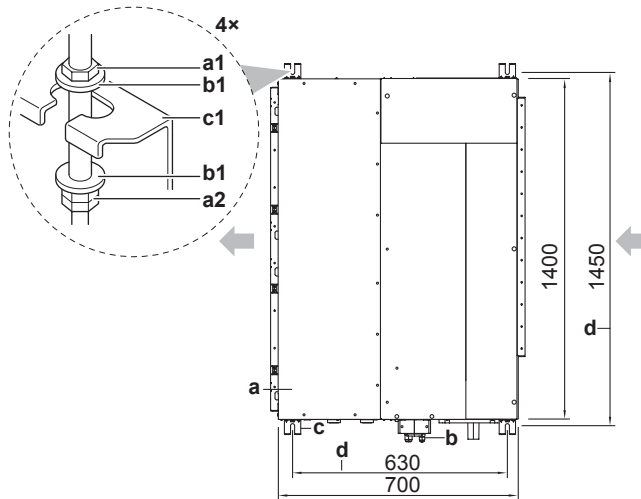

- a1 Nut (field supply)
- a2 Double nut (field supply)
- b1 Washer (accessories)
- c1 Hanger bracket (attached to the unit)
- a Indoor unit
- b Pipe
- c Hanger bracket pitch (suspension)
- d Suspension bolt spacing

▪ **Installation example:**

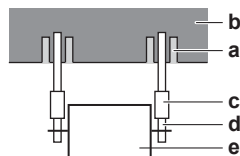

- a Anchor
- b Ceiling slab
- c Long nut or turn-buckle
- d Suspension bolt
- e Indoor unit

- **Install the unit temporarily.**

- 5 Attach the hanger bracket to the suspension bolt.
- 6 Fix it securely.
- **Level.** Make sure the unit is level at all four corners using a level or a water-filled vinyl tube.

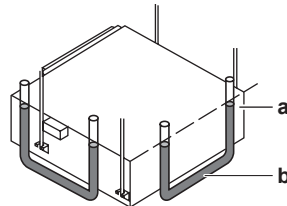

- a Water level
- b Vinyl tube

- 7 Tighten the upper nut.



NOTICE

Do NOT install the unit tilted. **Possible consequence:** If the unit is tilted against the direction of the condensate flow (the drain piping side is raised), the float switch might malfunction and cause water to drip.

16.2.2 Guidelines when installing the ducting



WARNING

Do NOT install operating ignition sources (example: open flames, an operating gas appliance or an operating electric heater) in the duct work.



CAUTION

- Make sure the installation of the duct does NOT exceed the setting range of the external static pressure for the unit. Refer to the technical datasheet of your model for the setting range.
- Make sure to install the canvas duct so vibrations are NOT transmitted to the duct or ceiling. Use a sound-absorbing material (insulation material) for the lining of the duct and apply vibration insulation rubber to the hanging bolts.
- When welding, make sure NOT to spatter onto the drain pan or the air filter.
- If the metal duct passes through a metal lath, wire lath or metal plate of the wooden structure, separate the duct and wall electrically.
- Install the outlet grille in a position where the airflow will not come into direct contact with people.
- Do NOT use booster fans in the duct. Use the function to adjust the fan rate setting automatically (see "20 Configuration" ▶ 73).

The ducting is to be field supplied.

- **Air inlet side.** Attach the duct and intake-side flange (field supply). For connecting the flange, use 7 accessory screws.

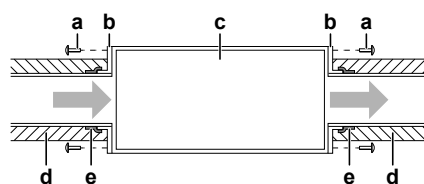

- a Connection screw (accessory)
- b Flange (field supply)
- c Main unit
- d Insulation (field supply)

e Aluminium tape (field supply)

- **Fixing screws.** When installing an air inlet duct, select fixing screws that stick out 5 mm on the inside of the flange to protect the air filter from damage during maintenance of the filter.

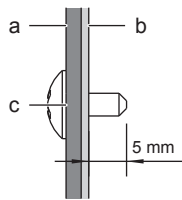

a Air inlet duct
b Inside of the flange
c Fixing screw

- **Filter.** Be sure to attach an air filter inside the air passage on the intake side. Use an air filter with dust collecting efficiency $\geq 50\%$ (gravimetric method). The included filter is not used when the intake duct is attached.
- **Air outlet side.** Connect the duct according to the inside dimension of the outlet-side flange.
- **Air leaks.** Wind aluminium tape around the intake side flange and duct connection. Make sure there are no air leaks at any other connection.
- **Insulation.** Insulate the duct to prevent condensation from forming. Use glass wool or polyethylene foam 25 mm thick.

16.2.3 Guidelines when installing the drain piping

Make sure condensation water can be evacuated properly. This involves:

- General guidelines
- Connecting the drain piping to the indoor unit
- Checking for water leaks

General guidelines

- **Drain pump.** For this "high lift type", the drainage sounds will be reduced when the drain pump is installed in a higher location. Recommended height is 300 mm.
- **Pipe length.** Keep drain piping as short as possible.
- **Pipe size.** Keep the pipe size equal to or greater than that of the connecting pipe (vinyl pipe of 20 mm nominal diameter and 26 mm outer diameter).
- **Slope.** Make sure the drain piping slopes down (at least 1/100) to prevent air from being trapped in the piping. Use hanging bars as shown.

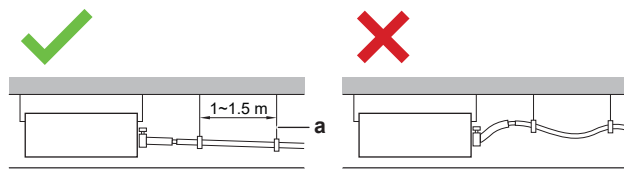

a Hanging bar
✓ Allowed
✗ Not allowed

- **Condensation.** Take measures against condensation. Insulate the complete drain piping in the building.

- **Rising piping.** If necessary to make the slope possible, you can install rising piping.
 - Drain hose inclination: 0~75 mm to avoid stress on the piping and to avoid air bubbles.
 - Rising piping: ≤ 300 mm from the unit, ≤ 625 mm perpendicular to the unit.

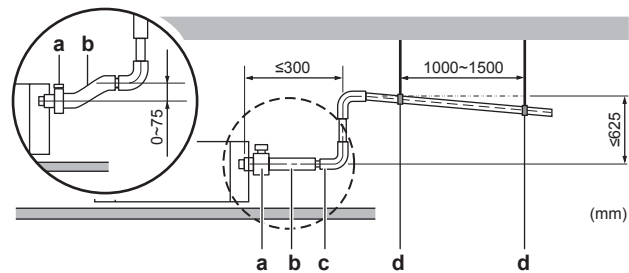

- a Metal clamp (accessory)
- b Drain hose (accessory)
- c Rising drain piping (vinyl pipe of 25 mm nominal diameter and 32 mm outer diameter) (field supply)
- d Hanging bars (field supply)

- **Combining drain pipes.** You can combine drain pipes. Make sure to use drain pipes and T-joints with the correct gauge for the operating capacity of the units.

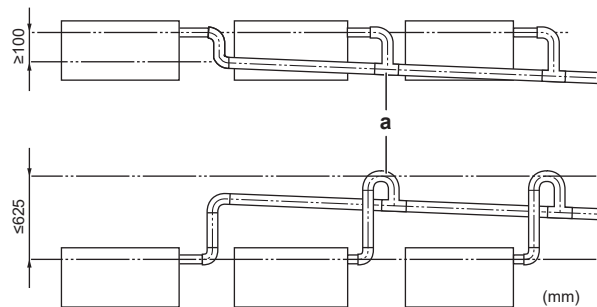

a T-joint

To connect the drain piping to the indoor unit



NOTICE

Incorrect connection of the drain hose might cause leaks, and damage the installation space and surroundings.

- 1 Push the drain hose as far as possible over the drain pipe connection.
- 2 Tighten the metal clamp until the screw head is less than 4 mm from the metal clamp part.
- 3 Check for water leaks (see "[To check for water leaks](#)" [▶ 57]).
- 4 Install the insulation piece (drain pipe).
- 5 Wind the large sealing pad (= insulation) around the metal clamp and drain hose, and fix it with cable ties.
- 6 Connect the drain piping to the drain hose.

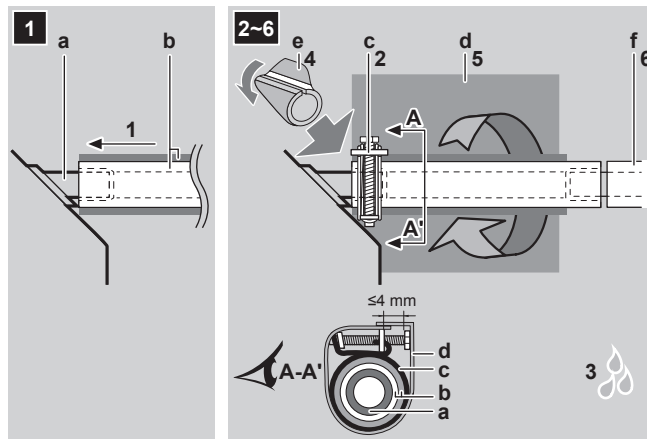

- a Drain pipe connection (attached to the unit)
- b Drain hose (accessory)
- c Metal clamp (accessory)
- d Large sealing pad (accessory)
- e Insulation piece (drain pipe) (accessory)
- f Drain piping (field supply)



NOTICE

- Do NOT remove the drain pipe plug. Water might leak out.
- Use the drain outlet only to discharge the water if the drain pump is not used or before maintenance.
- Insert and remove the drain plug gently. Excessive force may deform the drain socket of the drain pan.

Pull out the plug.

- Do NOT wiggle the plug up and down.

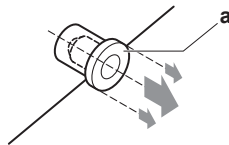

Push in the plug.

- Set the plug and push it in using a Phillips screwdriver.

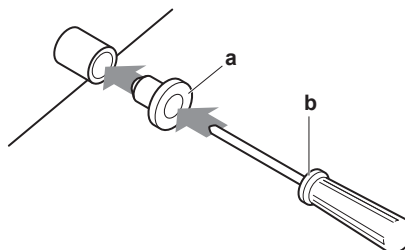

- a Drain plug
- b Phillips screwdriver

To check for water leaks

The procedure differs depending on whether electrical wiring is already finished. When electrical wiring is not finished yet, you need to temporarily connect the user interface and power supply to the unit.

When installation of the system is not yet completed

- 1 Temporarily connect electrical wiring.
- 2 Remove the switch box cover (a).

- 3 Connect the single-phase power supply (50 Hz, 230 V) to connections No. 1 and No. 2 on the terminal block for power supply and earth.
- 4 Reattach the switch box cover (a).
- 5 Turn ON the power.
- 6 Start cooling operation (see ["19.4 To perform a test run"](#) [▶ 72]).
- 7 Gradually pour approximately 1 l of water through the air discharge outlet, and check for leaks.

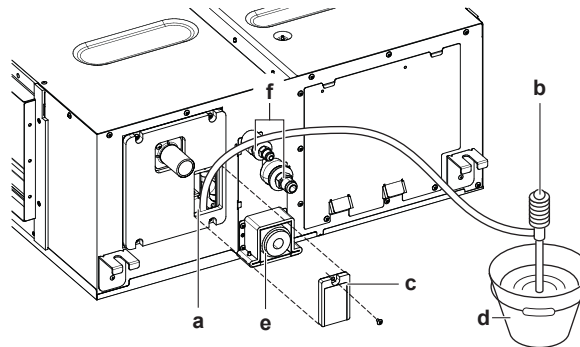

- a Water inlet
- b Portable pump
- c Water inlet cover
- d Bucket (adding water through water inlet)
- e Drain outlet for maintenance
- f Refrigerant pipes

- 8 Turn OFF the power.
- 9 Disconnect the electrical wiring.
- 10 Remove the control box cover.
- 11 Disconnect the power supply and earth.
- 12 Reattach the control box cover.

When installation of the system is already completed

- 1 Start cooling operation (see the reference guide or the service manual of the user interface).
- 2 Gradually pour approximately 1 l of water through the water inlet, and check for leaks (see ["When installation of the system is not yet completed"](#) [▶ 57]).

17 Piping installation

In this chapter

17.1	Preparing refrigerant piping	59
17.1.1	Refrigerant piping requirements	59
17.1.2	Refrigerant piping insulation	60
17.2	Connecting the refrigerant piping	60
17.2.1	About connecting the refrigerant piping	60
17.2.2	Precautions when connecting the refrigerant piping	60
17.2.3	Guidelines when connecting the refrigerant piping	61
17.2.4	Pipe bending guidelines	62
17.2.5	To flare the pipe end	62
17.2.6	To connect the refrigerant piping to the indoor unit	63

17.1 Preparing refrigerant piping

17.1.1 Refrigerant piping requirements



CAUTION

Piping **MUST** be installed according to instructions given in "[17 Piping installation](#)" [▶ 59]. Only mechanical joints (e.g. braze+flare connections) that are compliant with the latest version of ISO14903 can be used.



NOTICE

The piping and other pressure-containing parts shall be suitable for refrigerant. Use phosphoric acid deoxidised seamless copper for refrigerant piping.



INFORMATION

Also read the precautions and requirements in the "[2 General safety precautions](#)" [▶ 7].

- Foreign materials inside pipes (including oils for fabrication) must be ≤ 30 mg/10 m.

Refrigerant piping diameter

For piping connections of the indoor unit, use the following piping diameters:

Pipe outer diameter (mm)	
Liquid pipe	Gas pipe
Ø9.5	Ø15.9

Refrigerant piping material

- Piping material:** phosphoric acid deoxidised seamless copper
- Flare connections:** Only use annealed material.
- Piping temper grade and thickness:**

Outer diameter (Ø)	Temper grade	Thickness (t) ^(a)	
9.5 mm (3/8")	Annealed (O)	≥0.8 mm	
15.9 mm (5/8")	Annealed (O)		

^(a) Depending on the applicable legislation and the maximum working pressure of the unit (see "PS High" on the unit name plate), larger piping thickness might be required.

17.1.2 Refrigerant piping insulation

- Use polyethylene foam as insulation material:
 - with a heat transfer rate between 0.041 and 0.052 W/mK (0.035 and 0.045 kcal/mh°C)
 - with a heat resistance of at least 120°C
- Insulation thickness

Pipe outer diameter (\varnothing_p)	Insulation inner diameter (\varnothing_i)	Insulation thickness (t)
9.5 mm (3/8")	10~14 mm	≥13 mm
15.9 mm (5/8")	16~20 mm	≥13 mm

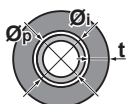

If the temperature is higher than 30°C and the humidity is higher than RH 80%, the thickness of the insulation materials should be at least 20 mm to prevent condensation on the surface of the insulation.

17.2 Connecting the refrigerant piping

17.2.1 About connecting the refrigerant piping

Before connecting the refrigerant piping

Make sure the outdoor and indoor unit are mounted.

Typical workflow

Connecting the refrigerant piping involves:

- Connecting the refrigerant piping to the indoor unit
- Connecting the refrigerant piping to the outdoor unit
- Insulating the refrigerant piping
- Keeping in mind the guidelines for:
 - Pipe bending
 - Flaring pipe ends
 - Using the stop valves

17.2.2 Precautions when connecting the refrigerant piping



INFORMATION

Also read the precautions and requirements in the following chapters:

- "2 General safety precautions" [▶ 7]
- "17.1 Preparing refrigerant piping" [▶ 59]



DANGER: RISK OF BURNING/SCALDING



NOTICE

- Do NOT use mineral oil on flared part.
- NEVER install a drier to this unit to guarantee its lifetime. The drying material may dissolve and damage the system.
- Use the flare nut fixed to the main unit.
- To prevent gas leakage, apply refrigeration oil only to the inside of the flare. Use refrigeration oil for R32/R410A.
- Do NOT reuse joints.



NOTICE

Take the following precautions on refrigerant piping into account:

- Avoid anything but the designated refrigerant to get mixed into the refrigerant cycle (e.g. air).
- Only use R32 or R410A when adding refrigerant. Refer to the outdoor unit specifications for the type of refrigerant to be used.
- Only use installation tools (e.g. manifold gauge set) that are exclusively used for R32 or R410A installations to withstand the pressure and to prevent foreign materials (e.g. mineral oils and moisture) from mixing into the system.
- Install the piping so that the flare is NOT subjected to mechanical stress.
- Do NOT leave pipes unattended at the site. If the installation is NOT done within 1 day, protect the piping as described in the following table to prevent dirt, liquid or dust from entering the piping.
- Use caution when passing copper tubes through walls (see figure below).

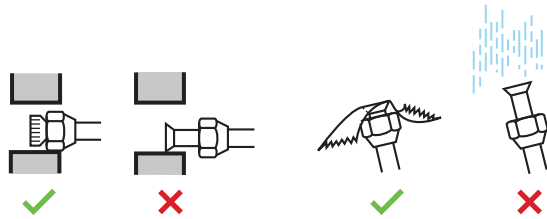

Unit	Installation period	Protection method
Outdoor unit	>1 month	Pinch the pipe
	<1 month	Pinch or tape the pipe
Indoor unit	Regardless of the period	



NOTICE

Do NOT open the refrigerant stop valve before checking the refrigerant piping. When you need to charge additional refrigerant it is recommended to open the refrigerant stop valve after charging.

17.2.3 Guidelines when connecting the refrigerant piping

Take the following guidelines into account when connecting pipes:

- Coat the flare inner surface with ether oil or ester oil when connecting a flare nut. Tighten 3 or 4 turns by hand, before tightening firmly.

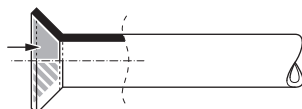

- ALWAYS use 2 wrenches together when loosening a flare nut.

- ALWAYS use a spanner and torque wrench together to tighten the flare nut when connecting the piping. This to prevent nut cracking and leaks.

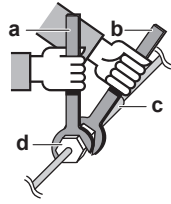

- a Torque wrench
- b Spanner
- c Piping union
- d Flare nut

Piping size (mm)	Tightening torque (N•m)	Flare dimensions (A) (mm)	Flare shape (mm)
∅9.5	33~39	12.8~13.2	
∅15.9	62~75	19.3~19.7	

17.2.4 Pipe bending guidelines

Use a pipe bender for bending. All pipe bends should be as gentle as possible (bending radius should be 30~40 mm or larger).

17.2.5 To flare the pipe end



CAUTION

- Incomplete flaring may cause refrigerant gas leakage.
- Do NOT re-use flares. Use new flares to prevent refrigerant gas leakage.
- Use flare nuts that are included with the unit. Using different flare nuts may cause refrigerant gas leakage.

- 1 Cut the pipe end with a pipe cutter.
- 2 Remove burrs with the cut surface facing down so that the chips do NOT enter the pipe.

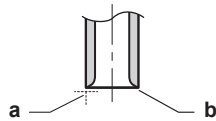

- a Cut exactly at right angles.
- b Remove burrs.

- 3 Remove the flare nut from the stop valve and put the flare nut on the pipe.
- 4 Flare the pipe. Set exactly at the position as shown in the following figure.

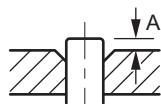

	Flare tool for R410A or R32 (clutch type)	Conventional flare tool	
		Clutch type (Rigid-type)	Wing nut type (Imperial-type)
A	0~0.5 mm	1.0~1.5 mm	1.5~2.0 mm

5 Check that the flaring is properly made.

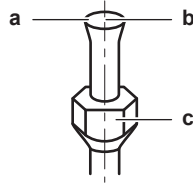

- a Flare's inner surface **MUST** be flawless.
- b The pipe end **MUST** be evenly flared in a perfect circle.
- c Make sure the flare nut is fitted.

17.2.6 To connect the refrigerant piping to the indoor unit



CAUTION

Install the refrigerant piping or components in a position where they are unlikely to be exposed to any substance which may corrode components containing refrigerant, unless the components are constructed of materials that are inherently resistant to corrosion or are suitably protected against corrosion.



WARNING: MILDLY FLAMMABLE MATERIAL

The R32 refrigerant (if applicable) in this unit is mildly flammable. Refer to the outdoor unit specifications for the type of refrigerant to be used.

- **Pipe length.** Keep refrigerant piping as short as possible.
- **Flare connections.** Connect refrigerant piping to the unit using flare connections.
- **Insulation.** Insulate the refrigerant piping on the indoor unit as follows:

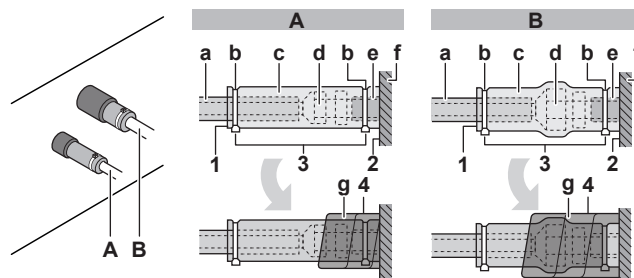

- A Liquid piping
- B Gas piping

- a Insulation material (field supply)
- b Tie wrap (field supply)
- c Insulation pieces: Large (gas pipe), small (liquid pipe) (accessories)
- d Flare nut (attached to the unit)
- e Refrigerant pipe connection (attached to the unit)
- f Unit
- g Sealing pads: Medium 1 (gas pipe), medium 2 (liquid pipe) (accessories)

- 1 Turn up the seams of the insulation pieces.
- 2 Attach to the base of the unit.
- 3 Tighten the tie wrap on the insulation pieces.
- 4 Wrap the sealing pad from the base of the unit to the top of the flare nut.



NOTICE

Make sure to insulate all refrigerant piping. Any exposed piping might cause condensation.

18 Electrical installation

In this chapter

18.1	About connecting the electrical wiring	64
18.1.1	Precautions when connecting the electrical wiring	64
18.1.2	Guidelines when connecting the electrical wiring	65
18.1.3	Specifications of standard wiring components	67
18.2	To connect the electrical wiring to the indoor unit	67

18.1 About connecting the electrical wiring

Typical workflow

Connecting the electrical wiring typically consists of the following stages:

- 1 Making sure the power supply system complies with the electrical specifications of the units.
- 2 Connecting the electrical wiring to the outdoor unit.
- 3 Connecting the electrical wiring to the indoor unit.
- 4 Connecting the main power supply.

18.1.1 Precautions when connecting the electrical wiring



DANGER: RISK OF ELECTROCUTION



WARNING

- All wiring **MUST** be performed by an authorised electrician and **MUST** comply with the applicable national wiring regulation.
- Make electrical connections to the fixed wiring.
- All components procured on-site and all electrical construction **MUST** comply with the applicable legislation.



WARNING

ALWAYS use multicore cable for power supply cables.



INFORMATION

Also read the precautions and requirements in the "[2 General safety precautions](#)" [[▶ 7](#)].



INFORMATION

Also read "[18.1.3 Specifications of standard wiring components](#)" [[▶ 67](#)].

**WARNING**

- If the power supply has a missing or wrong N-phase, equipment might break down.
- Establish proper earthing. Do NOT earth the unit to a utility pipe, surge absorber, or telephone earth. Incomplete earthing may cause electrical shock.
- Install the required fuses or circuit breakers.
- Secure the electrical wiring with cable ties so that the cables do NOT come in contact with sharp edges or piping, particularly on the high-pressure side.
- Do NOT use taped wires, extension cords, or connections from a star system. They can cause overheating, electrical shock or fire.
- Do NOT install a phase advancing capacitor, because this unit is equipped with an inverter. A phase advancing capacitor will reduce performance and may cause accidents.

**WARNING**

Use an all-pole disconnection type breaker with at least 3 mm between the contact point gaps that provides full disconnection under overvoltage category III.

**WARNING**

If the supply cord is damaged, it MUST be replaced by the manufacturer, its service agent or similarly qualified persons in order to avoid a hazard.

**WARNING**

Prevent hazards due to inadvertent resetting of the thermal cut-out: power to this appliance MUST NOT be supplied through an external switching device, such as a timer, or connected to a circuit that is regularly turned ON and OFF by the utility.

18.1.2 Guidelines when connecting the electrical wiring

Keep the following in mind:

**NOTICE**

We recommend using solid (single-core) wires. If stranded wires are used, slightly twist the strands to consolidate the end of the conductor for either direct use in the terminal clamp or insertion in a round crimp-style terminal.

To prepare stranded conductor wire for installation

Method 1: Twisting conductor

- 1 Strip insulation (20 mm) from the wires.
- 2 Slightly twist the end of the conductor to create a "solid-like" connection.

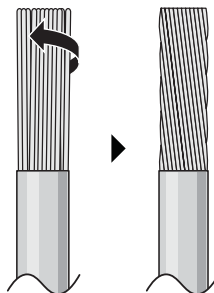

Method 2: Using round crimp-style terminal

- 1 Strip insulation from wires and slightly twist the end of each wire.
- 2 Install a round crimp-style terminal on the end of the wire. Place the round crimp-style terminal on the wire up to the covered part and fasten the terminal with the appropriate tool.

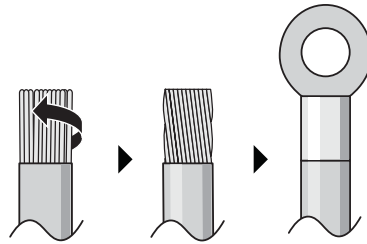

Use the following methods for installing wires:

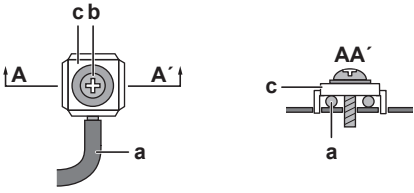
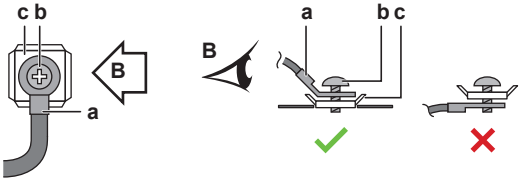
Wire type	Installation method
Single-core wire Or Stranded conductor wire twisted to "solid-like" connection	 <p>a Curled wire (single-core or twisted stranded conductor wire) b Screw c Flat washer</p>
Stranded conductor wire with round crimp-style terminal	 <p>a Terminal b Screw c Flat washer ✓ Allowed ✗ NOT allowed</p>

18.1.3 Specifications of standard wiring components

Component		FDA125A
Power supply cable	MCA ^(a)	2.1 A
	Voltage	220~240 V
	Current	2.1 A
	Phase	1~
	Frequency	50/60 Hz
	Wire sizes	MUST comply with national wiring regulation. 3-core cable Wire size based on the current, but not less than 2.5 mm ²
Interconnection cable (indoor↔outdoor)	Voltage	220~240 V
	Wire size	Only use harmonised wire providing double insulation and suitable for applicable voltage. 4-core cable Minimum 1.5 mm ²
User interface cable	Wire size	Only use harmonised wire providing double insulation and suitable for applicable voltage 2-core wire
	Wire length	Maximum 500 m
Recommended field fuse		16 A
Earth leakage circuit breaker / residual current device		MUST comply with national wiring regulation

^(a) MCA=Minimum circuit ampacity. Stated values are maximum values (see electrical data of indoor unit for exact values).

18.2 To connect the electrical wiring to the indoor unit

**NOTICE**

- Follow the wiring diagram (delivered with the unit, located on the switch box cover).
- Make sure the electrical wiring does NOT obstruct proper reattachment of the service cover.

It is important to keep the power supply and the transmission wiring separated from each other. In order to avoid any electrical interference the distance between both wirings should ALWAYS be at least 50 mm.

**NOTICE**

Be sure to keep the power line and transmission line apart from each other. Transmission wiring and power supply wiring may cross, but may NOT run parallel.

- 1 Remove the service cover.
- 2 **User interface cable:** Route the cable through the frame, connect the cable to the terminal block, and fix the cable with a cable tie.
- 3 **Interconnection cable** (indoor↔outdoor): Route the cable through the frame, connect the cable to the terminal block (make sure the numbers match with the numbers on the outdoor unit, and connect the earth wire), and fix the cable with a cable tie.
- 4 Divide the small sealing (accessory) and wrap it around the cables to prevent water from entering the unit. Seal all gaps to prevent small animals from entering the system.
- 5 Reattach the service cover.

▪ **When using 1 user interface with 1 indoor unit.**

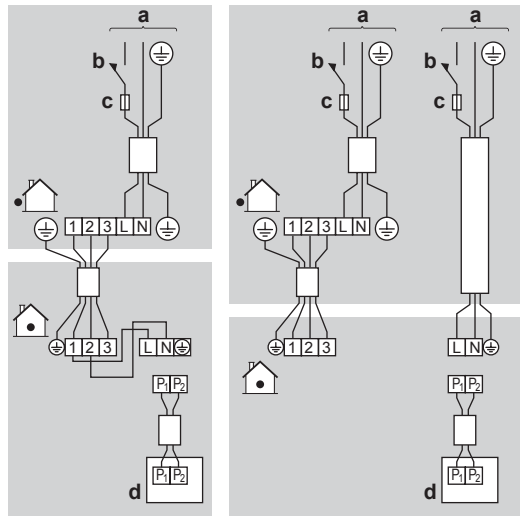

▪ **When using 2 user interfaces⁽¹⁾**

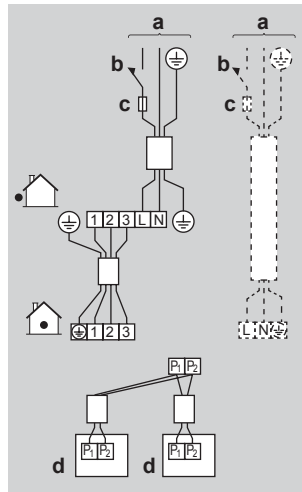

▪ **When using group control⁽¹⁾**

⁽¹⁾ Dashed line represents separate power supply.

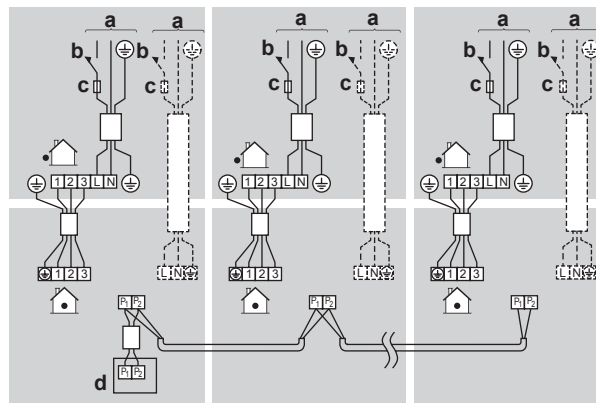

- a Power supply
- b Main switch
- c Fuse
- d User interface

- **Master unit:** Be sure to connect the wiring when combining with a simultaneously operating multi-type in group control.



INFORMATION

In case of group control, it is not necessary to assign a group address to the indoor unit. The group address is automatically set when the power is turned on.

- **EN/IEC 61000-3-12** provided that the short-circuit power S_{sc} is greater than or equal to the minimum S_{sc} value at the interface point between the user's supply and the public system.
 - EN/IEC 61000-3-12 = European/International Technical Standard setting the limits for harmonic currents produced by equipment connected to public low-voltage systems with input current >16 A and ≤ 75 A per phase.
 - It is the responsibility of the installer or user of the equipment to ensure, by consultation with the distribution network operator if necessary, that the equipment is connected ONLY to a supply with a short-circuit power S_{sc} greater than or equal to the minimum S_{sc} value.

To comply with EN/IEC 61000-3-12, following rules must be considered:

- In case of combination of units 2x FDA125A + RZQ250, use separate power supplies.

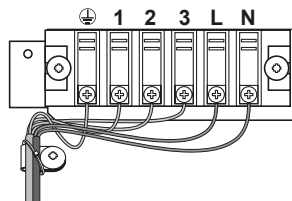

- Otherwise, refer to the table with S_{sc} values for FDA125A on the extranet.
 - If the S_{sc} value is NOT mentioned in the table for the used combination, use the common power supply wire delivered with the unit.
 - If the S_{sc} value is mentioned in the table, both the common power supply wire or a separate power supply can be used, but a separate power supply is preferred.

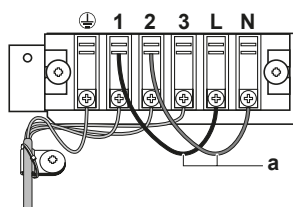

a Wire for common power supply (accessory)

19 Commissioning



NOTICE

General commissioning checklist. Next to the commissioning instructions in this chapter, a general commissioning checklist is also available on the Daikin Business Portal (authentication required).

The general commissioning checklist is complementary to the instructions in this chapter and can be used as a guideline and reporting template during commissioning and hand-over to the user.

In this chapter

19.1	Overview: Commissioning	71
19.2	Precautions when commissioning.....	71
19.3	Checklist before commissioning.....	71
19.4	To perform a test run	72

19.1 Overview: Commissioning

This chapter describes what you have to do and know to commission the system after it is installed.

Typical workflow

Commissioning typically consists of the following stages:

- 1 Checking the "Checklist before commissioning".
- 2 Performing a test run for the system.

19.2 Precautions when commissioning



INFORMATION

During the first running period of the unit, the required power may be higher than stated on the nameplate of the unit. This phenomenon is caused by the compressor, that needs a continuous run time of 50 hours before reaching smooth operation and stable power consumption.



NOTICE

ALWAYS operate the unit with thermistors and/or pressure sensors/switches. If NOT, burning of the compressor might be the result.



NOTICE

ALWAYS complete the refrigerant piping of the unit before operating. If NOT, the compressor will break.

19.3 Checklist before commissioning

- 1 After the installation of the unit, check the items listed below.
- 2 Close the unit.
- 3 Power up the unit.

<input type="checkbox"/>	You have read the complete installation and operation instructions described in the installer and user reference guide .
<input type="checkbox"/>	The indoor unit is properly mounted.
<input type="checkbox"/>	The outdoor unit is properly mounted.
<input type="checkbox"/>	The drain piping is properly installed and insulated, and drainage flows smoothly. Check for water leaks. Possible consequence: condensate water might drip.
<input type="checkbox"/>	The ducting is properly installed and insulated.
<input type="checkbox"/>	The refrigerant pipes (gas and liquid) are installed correctly and thermally insulated.
<input type="checkbox"/>	There are NO refrigerant leaks .
<input type="checkbox"/>	There are NO missing phases or reversed phases .
<input type="checkbox"/>	The system is properly earthed and the earth terminals are tightened.
<input type="checkbox"/>	The fuses or locally installed protection devices are installed according to this document, and have NOT been bypassed.
<input type="checkbox"/>	The power supply voltage matches the voltage on the identification label of the unit.
<input type="checkbox"/>	There are NO loose connections or damaged electrical components in the switch box.
<input type="checkbox"/>	There are NO damaged components or squeezed pipes on the inside of the indoor and outdoor units.
<input type="checkbox"/>	The stop valves (gas and liquid) on the outdoor unit are fully open.

19.4 To perform a test run



INFORMATION

- Perform the test run according to the instructions in the connected user interface manual.
- The test run is only completed if there is no malfunction code displayed on the user interface.
- See the service manual for the complete list of error codes and a detailed troubleshooting guideline for each error.



NOTICE

Do NOT interrupt the test run.

20 Configuration

20.1 Field setting

Make the following field settings so that they correspond with the actual installation setup and with the needs of the user:

- External static pressure setting using:
 - Airflow automatic adjustment setting
 - User interface
- Time to clean air filter

To set airflow automatic adjustment

- When the air conditioning unit is running in fan operation mode:

- 1 Stop the air conditioning unit.
- 2 Set value number / second code number to 03.

Setting content:	Then ⁽¹⁾		
	M	C1/SW	C2/—
Airflow adjustment is OFF	11(21)	7	01
Press ON/OFF to return to normal operating mode. Possible consequence: The operation lamp will light up and the unit will start the fan operation for airflow automatic adjustment.			03
Operation stops after 1 to 8 minutes. Possible consequence: Setting is finished and the operation lamp will be off.			02

If there is no change after airflow adjustment, perform the setting again.



INFORMATION

- The fan speed of the indoor unit is preset to ensure the standard external static pressure.
- To set a higher or lower external static pressure, reset the initial setting with the user interface.

User interface

Check the indoor unit setting: the value number / second code number of mode 11(21) must be set to 01.

Change the value number / second code number according to the external static pressure of the duct to be connected as in table below.

⁽¹⁾ Field settings are defined as follows:

- **M**: Mode number – **First number**: for group of units – **Number between brackets**: for individual unit
- **SW**: Setting number / **C1**: First code number
- **—**: Value number / **C2**: Second code number
- **■**: Default

M	C1/SW	C2/—	External static pressure ⁽¹⁾
13(23)	6	01	40
		02	50
		03	60
		04	70
		05	80
		06	90
		07	100
		08	110
		09	120
		10	130
		11	140
		12	150
		13	160
		14	180
		15	200

Time to clean air filter

This setting must correspond with the air contamination in the room. It determines the interval at which the **TIME TO CLEAN AIR FILTER** notification is displayed on the user interface. When using a wireless user interface, you must also set the address (see the installation manual of the user interface).

If you want an interval of... (air contamination)	ThenFN		
	M	C1/SW	C2/—
±2500 h (light)	10(20)	0	01
±1250 h (heavy)			02
No notification		3	02

- **2 user interfaces:** When using 2 user interfaces, one must be set to "MAIN" and the other to "SUB".

⁽¹⁾ Field settings are defined as follows:

- **M:** Mode number – **First number:** for group of units – **Number between brackets:** for individual unit
- **SW:** Setting number / **C1:** First code number
- **—:** Value number / **C2:** Second code number
- **■:** Default

21 Hand-over to the user

Once the test run is finished and the unit operates properly, make sure the following is clear for the user:

- Make sure that the user has the printed documentation and ask him/her to keep it for future reference. Inform the user that he can find the complete documentation at the URL mentioned earlier in this manual.
- Explain the user how to properly operate the system and what to do in case of problems.
- Show the user what to do for the maintenance of the unit.

22 Troubleshooting

22.1 Solving problems based on error codes

If the unit runs into a problem, the user interface displays an error code. It is important to understand the problem and to take measures before resetting an error code. This should be done by a licensed installer or by your local dealer.

This chapter gives you an overview of most possible error codes and their descriptions as they appear on the user interface.



INFORMATION

See the service manual for:

- The complete list of error codes
- A more detailed troubleshooting guideline for each error

22.1.1 Error codes: Overview

In case other error codes appear, contact your dealer.

Code	Description
<i>R1</i>	Malfunction of indoor unit PCB
<i>R3</i>	Drain level control system abnormality
<i>R4</i>	Malfunction of freezing protection
<i>R5</i>	High pressure control in heating, freeze-up protection control in cooling
<i>R6</i>	Malfunction of fan motor
<i>R7</i>	Malfunction of swing flap motor
<i>R8</i>	Malfunction of power supply or AC input overcurrent
<i>RF</i>	Malfunction of a humidifier system
<i>RH</i>	Malfunction of dust collector of air cleaner
<i>RJ</i>	Malfunction of capacity setting (Indoor unit PCB)
<i>C1</i>	Failure of transmission (between indoor unit PCB and sub PCB)
<i>C4</i>	Malfunction of liquid pipe thermistor for heat exchanger
<i>C5</i>	Malfunction of gas pipe thermistor for heat exchanger
<i>C6</i>	Malfunction of gas pipe thermistor for heat exchanger
<i>C9</i>	Malfunction of suction air thermistor
<i>CR</i>	Malfunction of discharge air thermistor
<i>CJ</i>	Room temperature thermistor in remote controller abnormality

23 Disposal

**NOTICE**

Do NOT try to dismantle the system yourself: dismantling of the system, treatment of the refrigerant, oil and other parts **MUST** comply with applicable legislation. Units **MUST** be treated at a specialised treatment facility for reuse, recycling and recovery.

















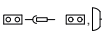

24 Technical data

- A **subset** of the latest technical data is available on the regional Daikin website (publicly accessible).
- The **full set** of latest technical data is available on the Daikin Business Portal (authentication required).

24.1 Wiring diagram

24.1.1 Unified wiring diagram legend

For applied parts and numbering, refer to the wiring diagram on the unit. Part numbering is by Arabic numbers in ascending order for each part and is represented in the overview below by "*" in the part code.

Symbol	Meaning	Symbol	Meaning
	Circuit breaker		Protective earth
			
			
	Connection		Protective earth (screw)
	Connector		Rectifier
	Earth		Relay connector
	Field wiring		Short-circuit connector
	Fuse		Terminal
	Indoor unit		Terminal strip
	Outdoor unit		Wire clamp
	Residual current device		

Symbol	Colour	Symbol	Colour
BLK	Black	ORG	Orange
BLU	Blue	PNK	Pink
BRN	Brown	PRP, PPL	Purple
GRN	Green	RED	Red
GRY	Grey	WHT	White
SKY BLU	Sky blue	YLW	Yellow

Symbol	Meaning
A*P	Printed circuit board
BS*	Pushbutton ON/OFF, operation switch
BZ, H*O	Buzzer
C*	Capacitor

Symbol	Meaning
AC*, CN*, E*, HA*, HE*, HL*, HN*, HR*, MR*_A, MR*_B, S*, U, V, W, X*A, K*R_*, NE	Connection, connector
D*, V*D	Diode
DB*	Diode bridge
DS*	DIP switch
E*H	Heater
FU*, F*U, (for characteristics, refer to PCB inside your unit)	Fuse
FG*	Connector (frame ground)
H*	Harness
H*P, LED*, V*L	Pilot lamp, light emitting diode
HAP	Light emitting diode (service monitor green)
HIGH VOLTAGE	High voltage
IES	Intelligent eye sensor
IPM*	Intelligent power module
K*R, KCR, KFR, KHuR, K*M	Magnetic relay
L	Live
L*	Coil
L*R	Reactor
M*	Stepper motor
M*C	Compressor motor
M*F	Fan motor
M*P	Drain pump motor
M*S	Swing motor
MR*, MRCW*, MRM*, MRN*	Magnetic relay
N	Neutral
n=*, N=*	Number of passes through ferrite core
PAM	Pulse-amplitude modulation
PCB*	Printed circuit board
PM*	Power module
PS	Switching power supply
PTC*	PTC thermistor
Q*	Insulated gate bipolar transistor (IGBT)
Q*C	Circuit breaker
Q*DI, KLM	Earth leak circuit breaker
Q*L	Overload protector

Symbol	Meaning
Q*M	Thermo switch
Q*R	Residual current device
R*	Resistor
R*T	Thermistor
RC	Receiver
S*C	Limit switch
S*L	Float switch
S*NG	Refrigerant leak detector
S*NPH	Pressure sensor (high)
S*NPL	Pressure sensor (low)
S*PH, HPS*	Pressure switch (high)
S*PL	Pressure switch (low)
S*T	Thermostat
S*RH	Humidity sensor
S*W, SW*	Operation switch
SA*, F1S	Surge arrester
SR*, WLU	Signal receiver
SS*	Selector switch
SHEET METAL	Terminal strip fixed plate
T*R	Transformer
TC, TRC	Transmitter
V*, R*V	Varistor
V*R	Diode bridge, Insulated-gate bipolar transistor (IGBT) power module
WRC	Wireless remote controller
X*	Terminal
X*M	Terminal strip (block)
Y*E	Electronic expansion valve coil
Y*R, Y*S	Reversing solenoid valve coil
Z*C	Ferrite core
ZF, Z*F	Noise filter

25 Glossary

Dealer

Sales distributor for the product.

Authorised installer

Technical skilled person who is qualified to install the product.

User

Person who is owner of the product and/or operates the product.

Applicable legislation

All international, European, national and local directives, laws, regulations and/or codes that are relevant and applicable for a certain product or domain.

Service company

Qualified company which can perform or coordinate the required service to the product.

Installation manual

Instruction manual specified for a certain product or application, explaining how to install, configure and maintain it.

Operation manual

Instruction manual specified for a certain product or application, explaining how to operate it.

Maintenance instructions

Instruction manual specified for a certain product or application, which explains (if relevant) how to install, configure, operate and/or maintain the product or application.

Accessories

Labels, manuals, information sheets and equipment that are delivered with the product and that need to be installed according to the instructions in the accompanying documentation.

Optional equipment

Equipment made or approved by Daikin that can be combined with the product according to the instructions in the accompanying documentation.

Field supply

Equipment NOT made by Daikin that can be combined with the product according to the instructions in the accompanying documentation.





ERC

Copyright 2017 Daikin

DAIKIN EUROPE N.V.
Zandvoordestraat 300, B-8400 Oostende, Belgium

4P495031-1B 2022.10